

2020 Central District III Horse and Pony Show Example Patterns



<b>Showmanship</b>	Junior	#100-106	2
	Intermediate	#201-203	5
	Senior	#301-304	7
<b>English Equitation</b>	Walk-Trot	#441-444	9
	Junior	#141-144	11
	Intermediate	#241-244	13
	Senior	#341-344	15
<b>English Equitation Over Fences</b>	Level I	#551-552	17
	Level II-IV	#561-562	18
<b>Western Riding</b>	Intermediate & Senior	#771-784	19
<b>Western Horsemanship</b>	Walk-Trot	#411-413	23
	Junior	#111-113	25
	Intermediate	#211-214	27
	Senior	#311-315	29
<b>Reining</b>	Walk-Trot	#421-424	32
	Junior	#121-124	34
	Intermediate	#221-223	36
	Senior	#321-323	38
<b>Ranch Riding</b>	Junior	#131-134	40
	Intermediate & Senior	#321-323	42
<b>Trail Obstacle Options</b>	All ages		45
<b>Mini's</b>			
<b>Showmanship</b>	All ages	#901-904	46
<b>Driving Obstacles</b>	All ages	#910-911	48
<b>Trail Obstacle Options</b>	All ages		49

# Showmanship Jr

Reviewed 3/14/2018

## Pattern #101

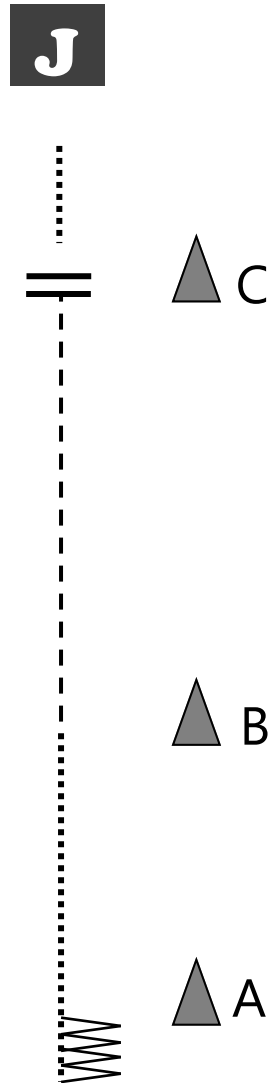
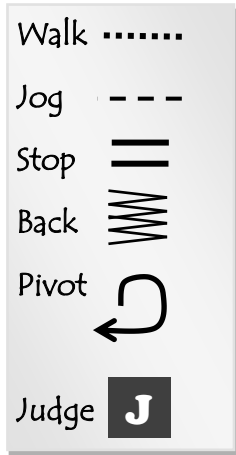

1. Set up at **A**
2. Back 5 steps
3. Walk to **B**
4. Jog to **C**, Stop
5. Walk to Judge, Set up for Inspection
6. Walk to line-up or exit as instructed.

# Showmanship Jr

Reviewed 3/14/2018

## Pattern #102

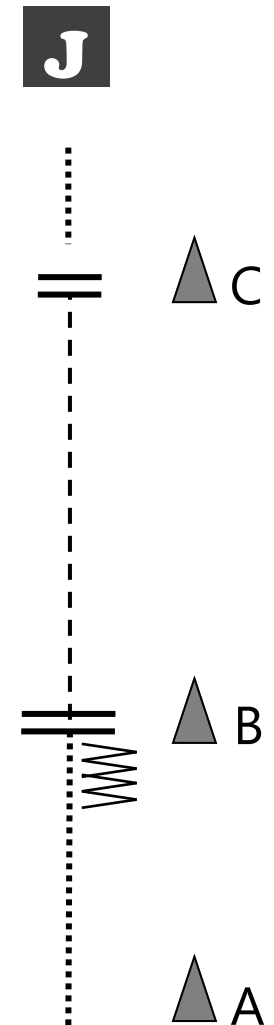
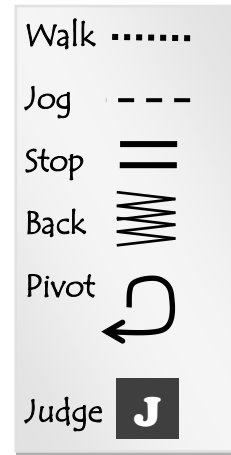

1. Set up at **A**
2. Walk to **B**, Stop
3. Back 5 steps
4. Jog to **C**, Stop
5. Walk to Judge, Set up for Inspection
6. Walk to line-up or exit as instructed.

# Showmanship - Jr

Reviewed 3/14/2018

Pattern #103

# Showmanship - Jr

Reviewed 3/14/2018

Pattern #104

**J**

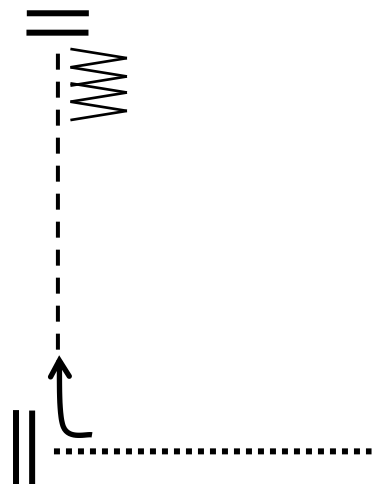

**B**

**A**

Walk .....  
 Jog - - - -  
 Stop ||||  
 Back WWWW  
 Pivot ↻  
 Judge **J**

1. Set up at **A**,
2. Walk to **B**, Stop
3. Pivot 90°, Jog to Judge
4. Stop, Set up for Inspection
5. Back 5 steps
6. Walk to line-up or exit as instructed.

**J**

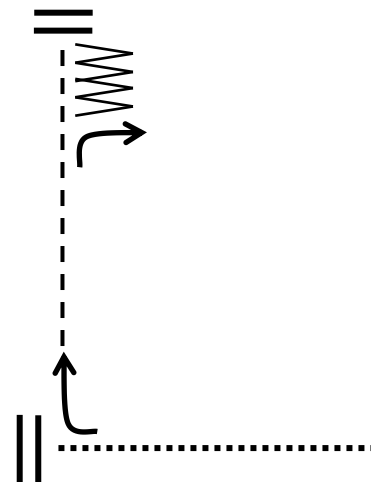

**B**

**A**

Walk .....  
 Jog - - - -  
 Stop ||||  
 Back WWWW  
 Pivot ↻  
 Judge **J**

1. Set up at **A**,
2. Walk to **B**, Stop
3. Pivot 90°, Jog to Judge
4. Stop, Set up for Inspection
5. Back 5 steps
6. Pivot 90°
7. Walk to line-up or exit as instructed.

# Showmanship - Jr

Reviewed 3/14/2018

## Pattern #105

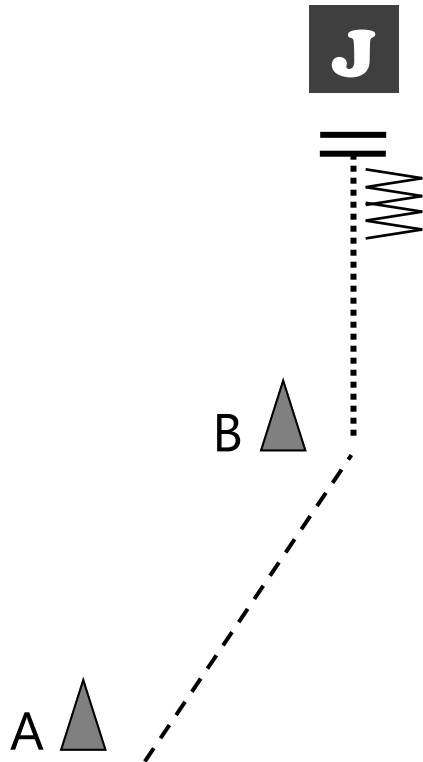

1. Set up at **A**
2. Jog to **B**
3. Walk to Judge
4. Stop, Set up for Inspection
5. Back 5
6. Walk to line-up or exit as instructed.

Walk .....  
 Jog - - - -  
 Stop ||||  
 Back WWWW  
 Pivot ↻  
 Judge **J**

# Showmanship - Jr

Reviewed 3/14/2018

## Pattern #106

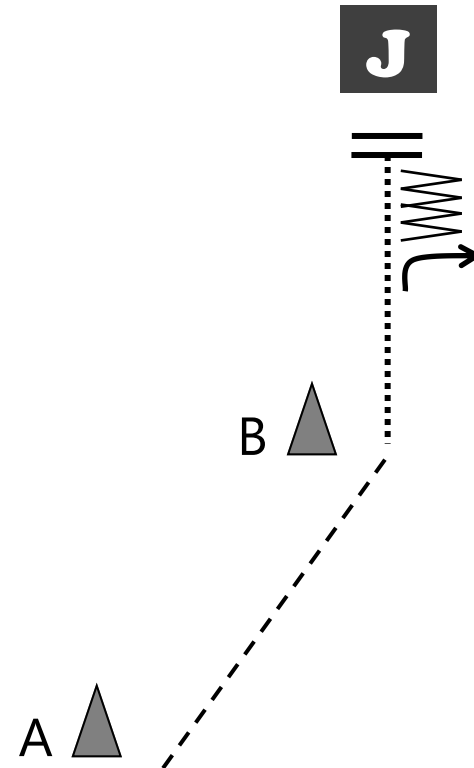

1. Set up at **A**
2. Jog to **B**
3. Walk to Judge
4. Stop, Set up for Inspection
5. Back 5 steps
6. Pivot 90°
7. Walk to line-up or exit as instructed.

Walk .....  
 Jog - - - -  
 Stop ||||  
 Back WWWW  
 Pivot ↻  
 Judge **J**

# Showmanship - Int.

Reviewed 3/14/2018

## Pattern #201

Walk .....  
 Jog - - -  
 Stop ||  
 Back W W W  
 Pivot ↻  
 Judge J

1. Set up at **A**
2. Walk to **B**
3. Jog to **C**, Stop
4. Walk to Judge, Set up for Inspection
5. Back 5 steps
6. Pivot 270°
7. Walk to line-up or exit as instructed.

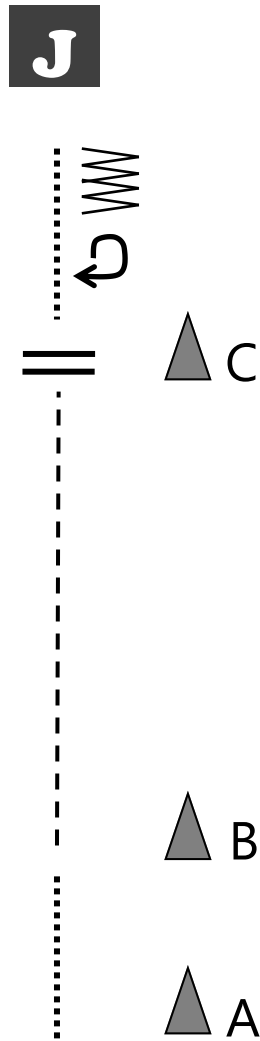

# Showmanship - Int

Reviewed 3/14/2018

## Pattern #202

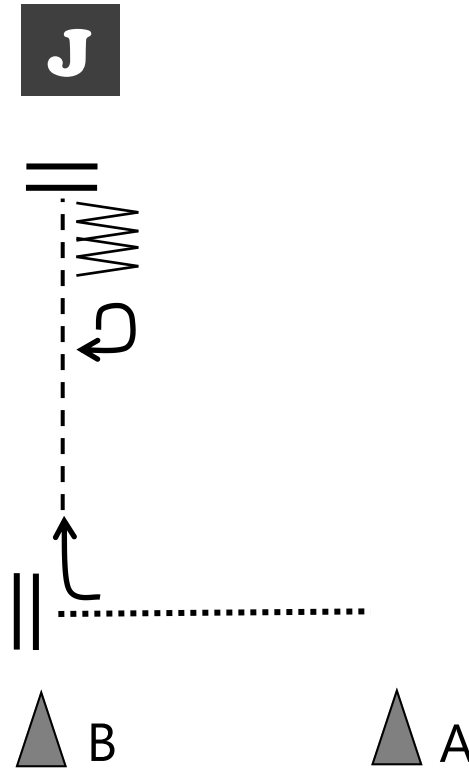

1. Set up at **A**,
2. Walk to **B**, Stop
3. Pivot 90°, Jog to Judge
4. Stop, Set up for Inspection
5. Back 5 steps
6. Pivot 270°
7. Walk to line-up or exit as instructed.

Walk .....  
 Jog - - -  
 Stop ||  
 Back W W W  
 Pivot ↻  
 Judge J

# Showmanship - Int

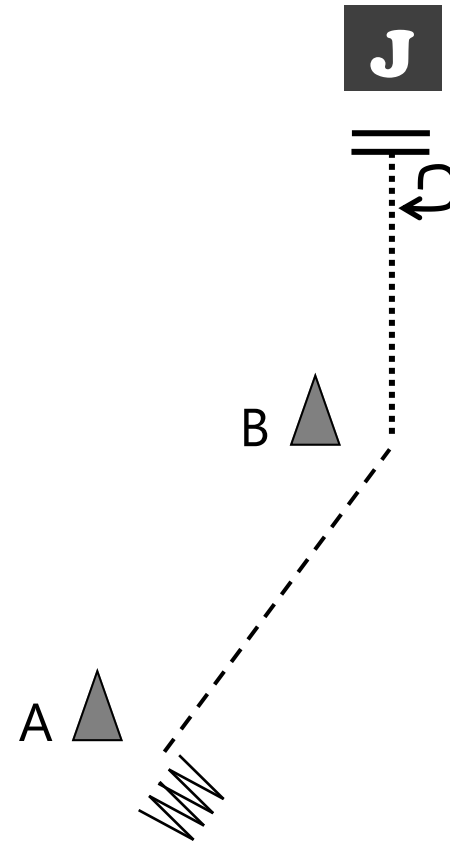

1. Set up at **A**
2. Back 5 steps
3. Jog to **B**
4. Walk to Judge
5. Stop, Set up for Inspection
6. Pivot 270°
7. Walk to line-up or exit as instructed.

Walk .....  
Jog - - - -  
Stop ||||  
Back WWWW  
Pivot ↻  
Judge **J**

# Showmanship - Sr

Reviewed 3/14/2018

Pattern #301

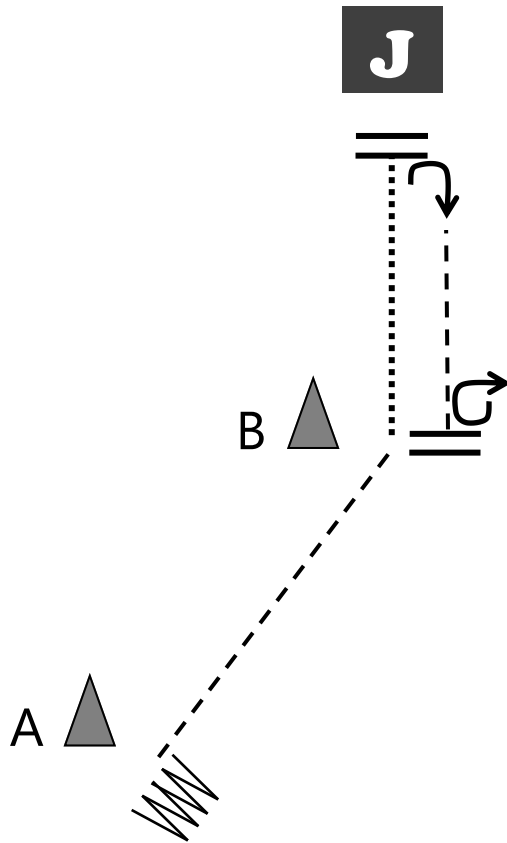

1. Set up at **A**
2. Back 5 steps
3. Jog to **B**
4. Walk to Judge
5. Stop, Set up for Inspection
6. Pivot 180°
7. Jog to **B**, Stop
8. Pivot 270°
9. Walk to line-up or exit as instructed.

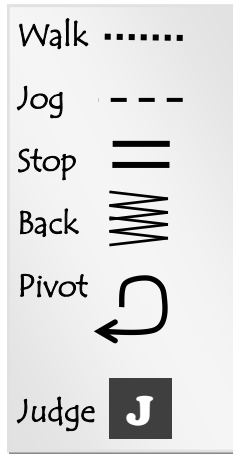

# Showmanship - Sr

Reviewed 3/14/2018

Pattern #302

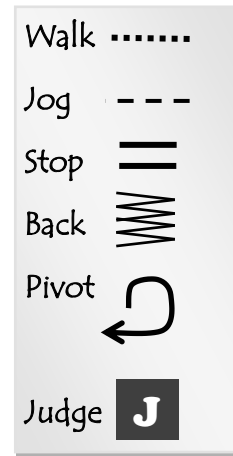
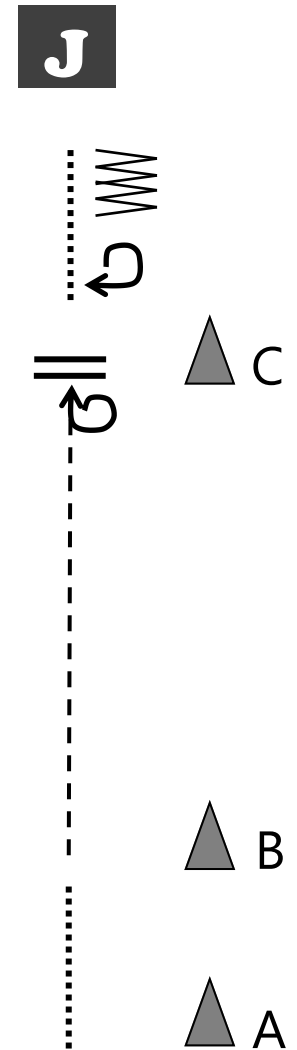

1. Set up at **A**
2. Walk to **B**
3. Jog to **C**
4. Stop, Pivot 360°
5. Walk to Judge, Set up for Inspection
6. Back 5 steps
7. Pivot 270°
8. Walk to line-up or exit as instructed.

# Showmanship - Sr

Reviewed 3/14/2018

Pattern #303

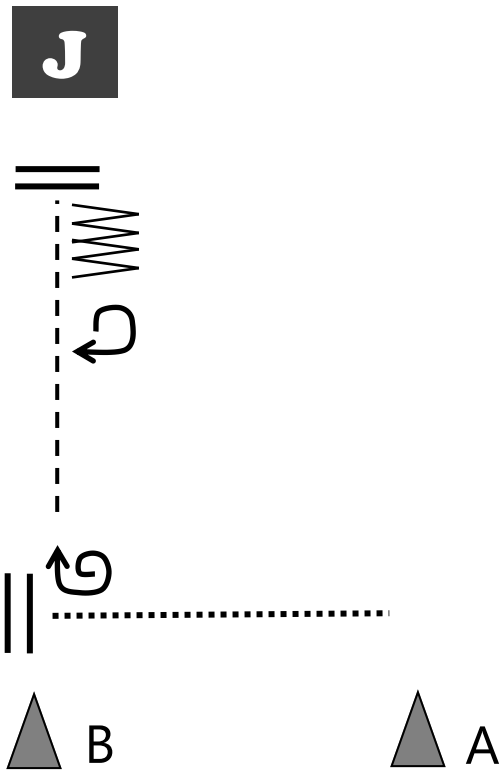

1. Set up at **A**,
2. Walk to **B**, Stop
3. Pivot 450°, Jog to Judge
4. Stop, Set up for Inspection
5. Back 5 steps
6. Pivot 270°
7. Walk to line-up or exit as instructed.

Walk .....  
 Jog - - - -  
 Stop ||  
 Back M M M M  
 Pivot ↻  
 Judge J

# Showmanship - Sr

Reviewed 3/14/2018

Pattern #304

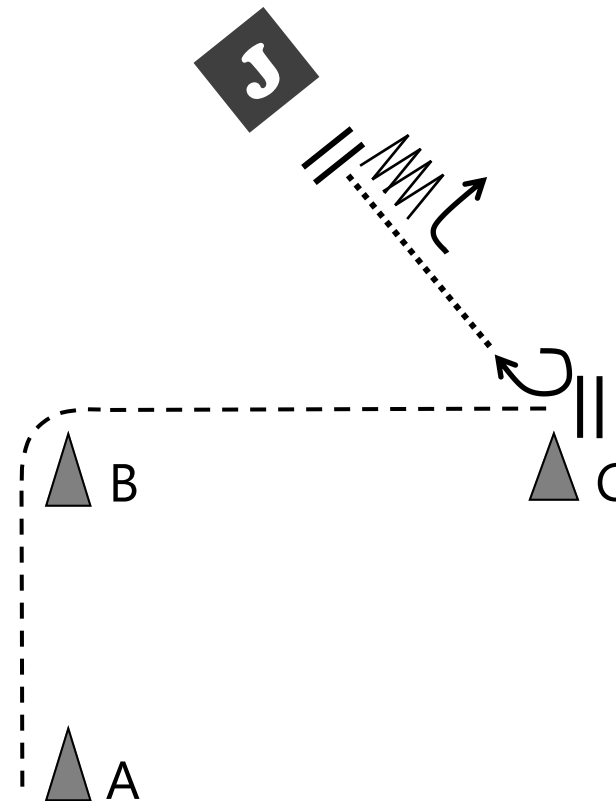

1. Set up at **A**,
2. Jog around **B** to **C**, Stop
3. Pivot 225°, Walk to Judge
4. Stop, Set up for Inspection
5. Back 5 steps
6. Pivot 90°
7. Walk to line-up or exit as instructed.

Walk .....  
 Jog - - - -  
 Stop ||  
 Back M M M M  
 Pivot ↻  
 Judge J



# English Equitation Walk-Trot

Reviewed 3/22/2018

## Pattern #443

Walk	.....
Sitting Trot	- - - -
Rising Trot	. . . .
Canter	—
Halt	
Lead Change	///
Back	\\
Pivot	↻

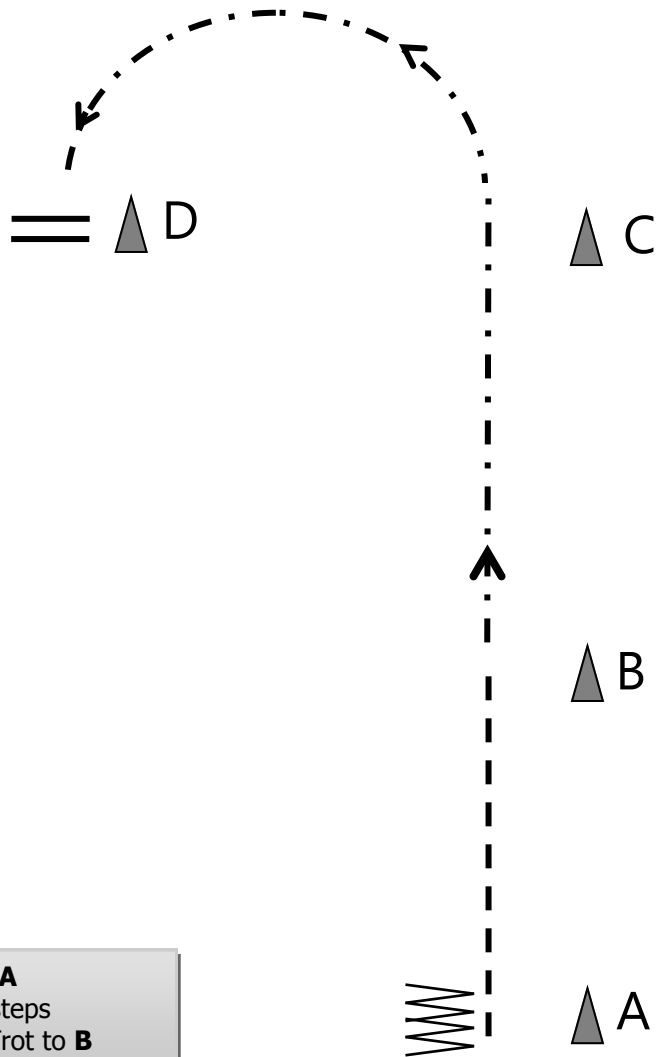

1. Start at **A**
2. Back 5 steps
3. Sitting Trot to **B**
4. Rising Trot to **C** and around to **D**
5. Halt

# English Equitation Walk-Trot

Reviewed 3/22/2018

## Pattern #444

Walk	.....
Sitting Trot	- - - -
Rising Trot	. . . .
Canter	—
Halt	
Lead Change	///
Back	\\
Pivot	↻

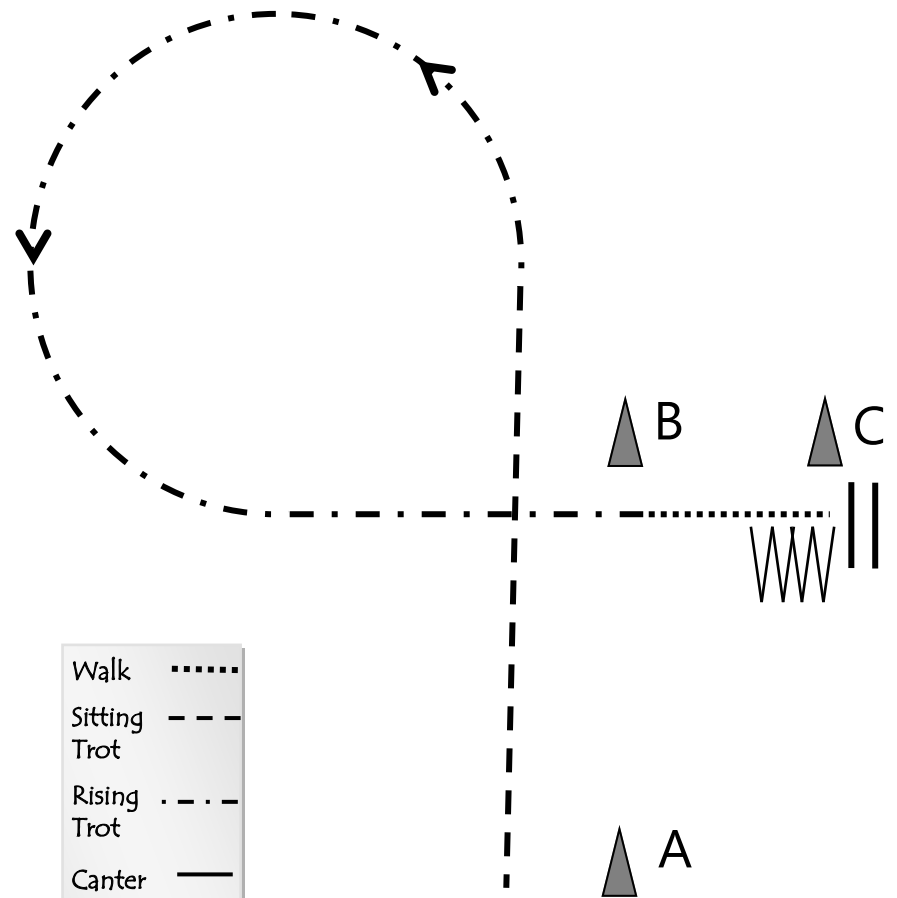

1. Start at **A**
2. Sitting Trot to **B**
3. Rising Trot Left circle back to **B**
4. Walk to **C**
5. Halt
6. Back 5 steps

# English Equitation Walk-Trot

Reviewed 3/22/2018

## Pattern #441

Walk	.....
Sitting Trot	- - - -
Rising Trot	. . . .
Canter	—
Halt	==
Lead Change	///
Back	\\
Pivot	↻

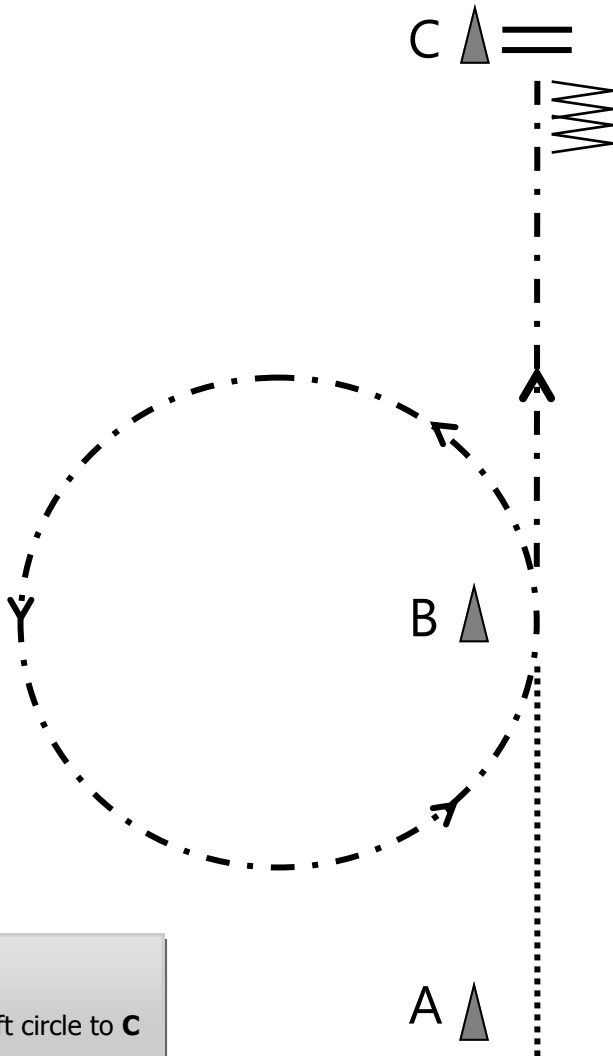

1. Stop at **A**
2. Walk to **B**
3. Rising Trot Left circle to **C**
4. Halt
5. Back 3-4 steps

# English Equitation Walk-Trot

Reviewed 3/22/2018

## Pattern #442

Walk	.....
Sitting Trot	- - - -
Rising Trot	. . . .
Canter	—
Halt	==
Lead Change	///
Back	\\
Pivot	↻

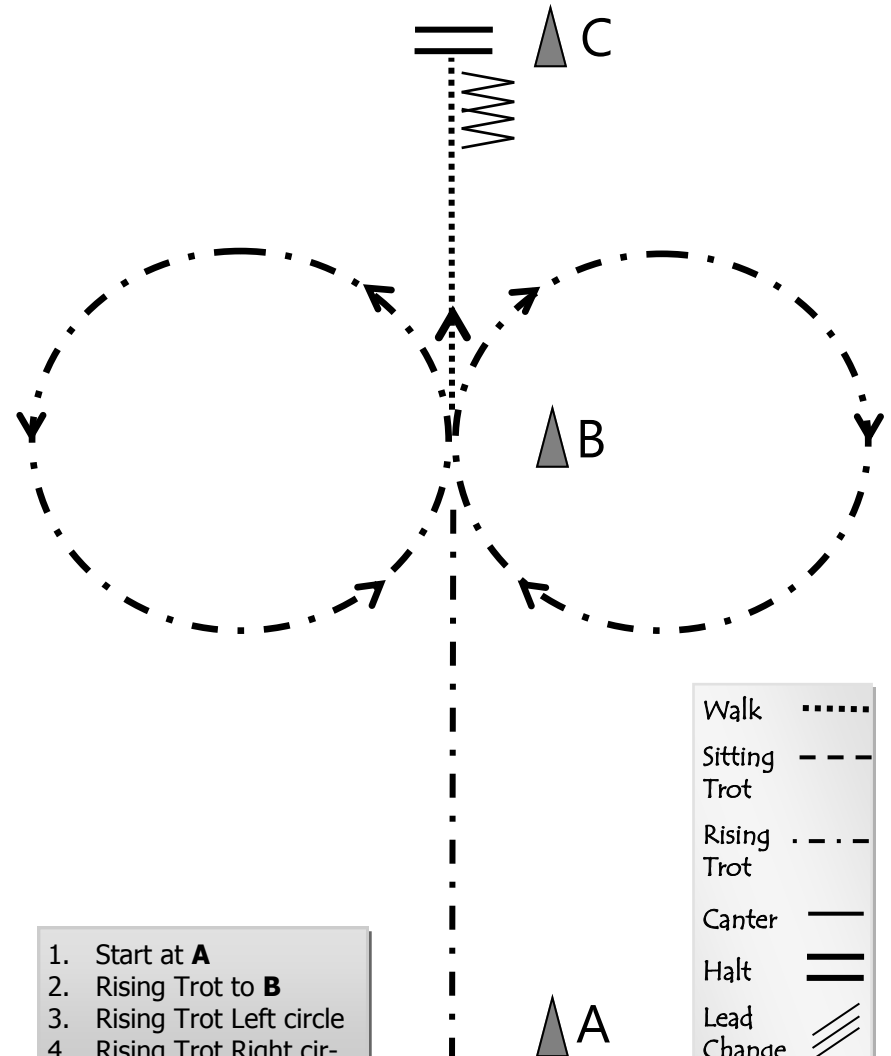

1. Start at **A**
2. Rising Trot to **B**
3. Rising Trot Left circle
4. Rising Trot Right circle
5. Walk to **C**
6. Halt
7. Back 5 steps

# English Equitation Jr

Reviewed 3/22/2018

## Pattern #141

Walk	.....
Sitting Trot	- - - -
Rising Trot	. . . .
Canter	— — —
Halt	
Lead Change	////
Back	\\\\\\
Pivot	↻

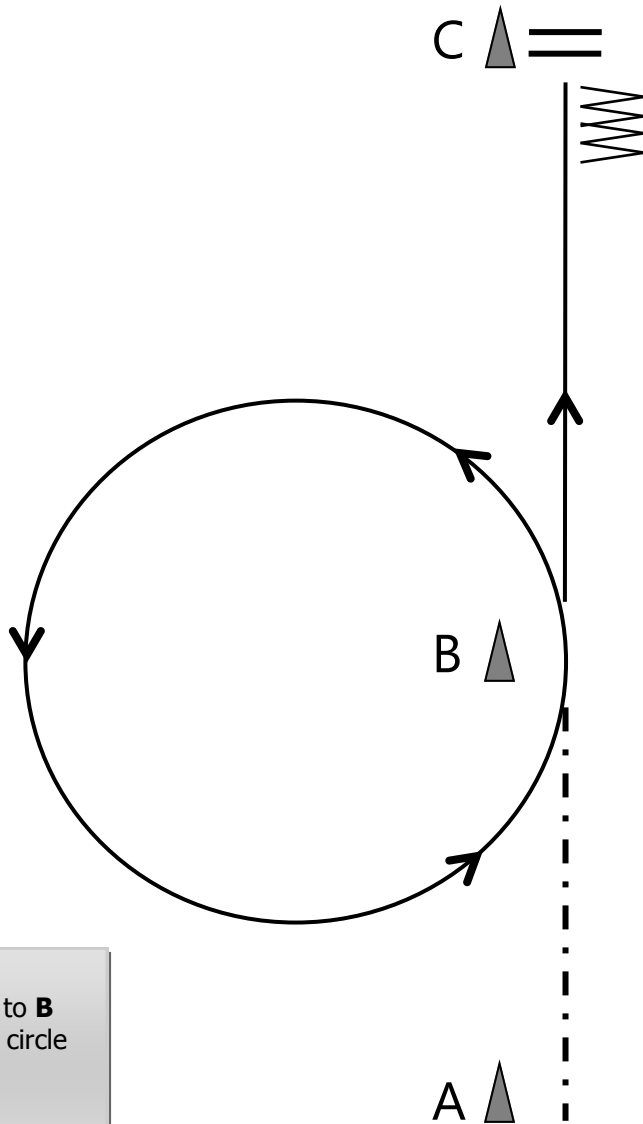

1. Stop at **A**
2. Rising Trot to **B**
3. Canter Left circle to **C**
4. Halt
5. Back 3-4 steps

# English Equitation Jr

Reviewed 3/22/2018

## Pattern #142

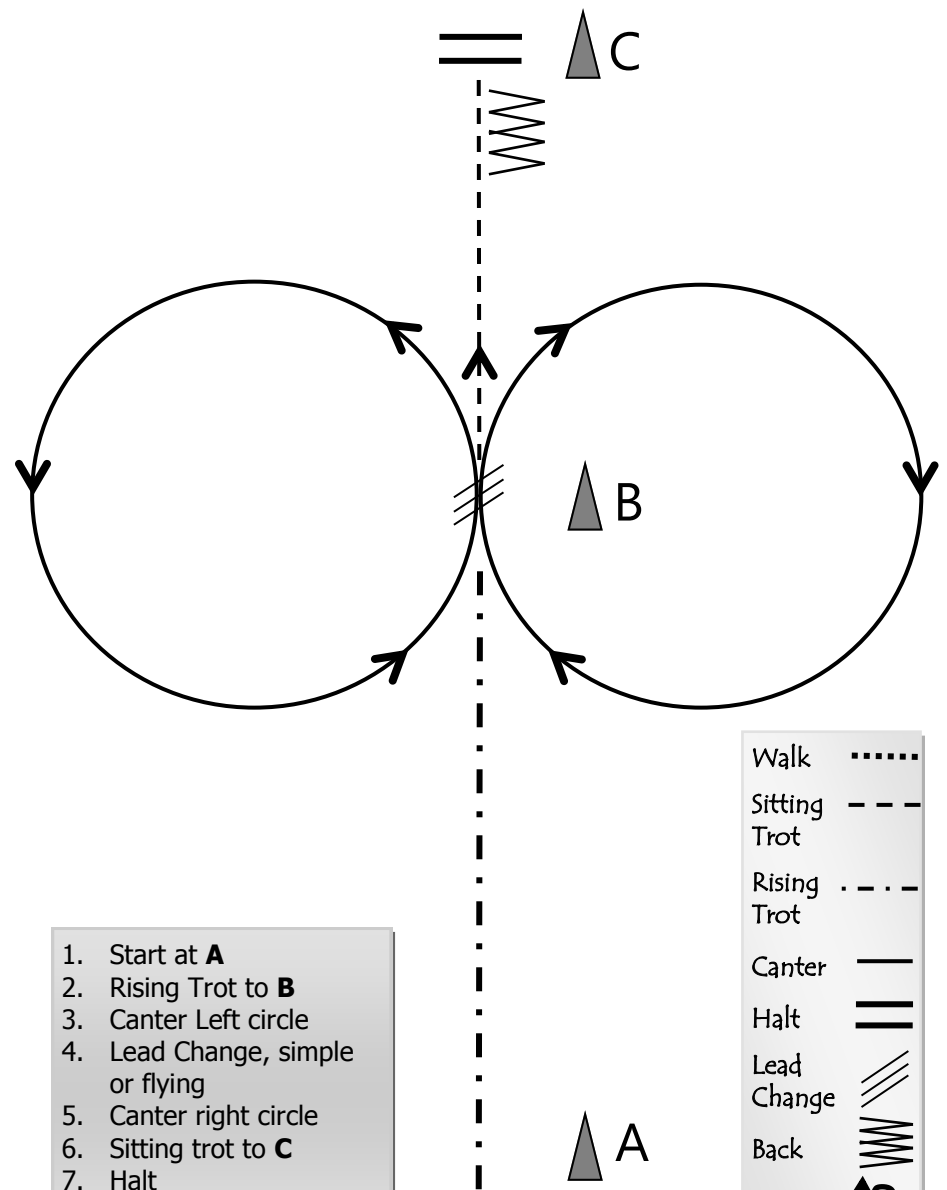

1. Start at **A**
2. Rising Trot to **B**
3. Canter Left circle
4. Lead Change, simple or flying
5. Canter right circle
6. Sitting trot to **C**
7. Halt
8. Back 5 steps

Walk	.....
Sitting Trot	- - - -
Rising Trot	. . . .
Canter	— — —
Halt	
Lead Change	////
Back	\\\\\\
Pivot	↻

# English Equitation Jr

Reviewed 3/22/2018

## Pattern #143

Walk	.....
Sitting Trot	- - - -
Rising Trot	. . . .
Canter	—
Halt	
Lead Change	///
Back	W W W
Pivot	↻

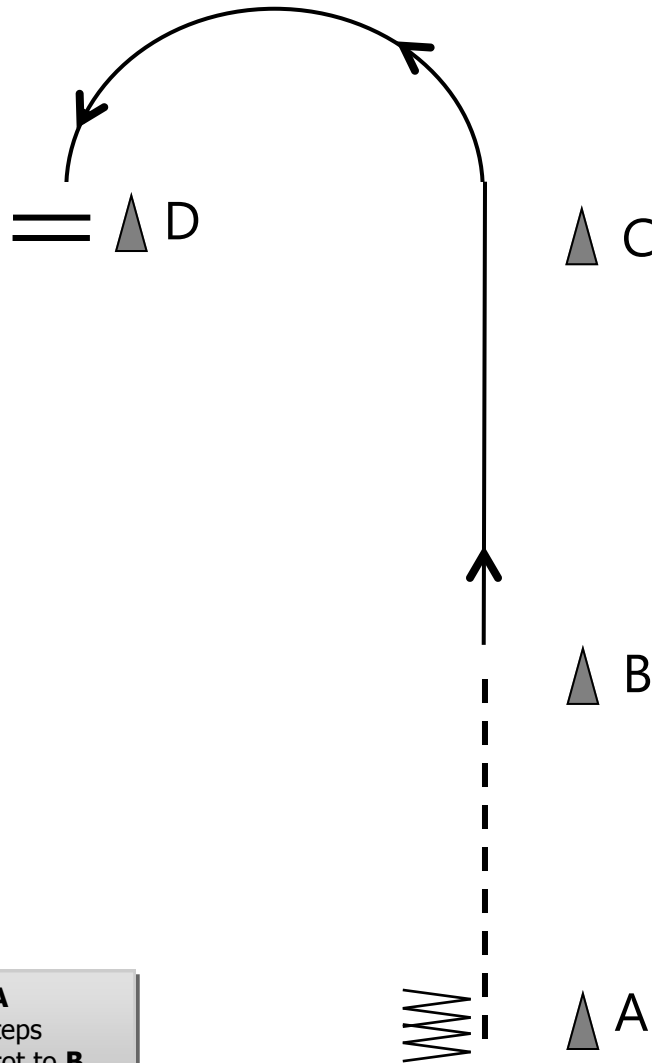

1. Start at **A**
2. Back 5 steps
3. Sitting Trot to **B**
4. Canter to **C** and around to **D**
5. Halt

# English Equitation Jr

Reviewed 3/22/2018

## Pattern #144

Walk	.....
Sitting Trot	- - - -
Rising Trot	. . . .
Canter	—
Halt	
Lead Change	///
Back	W W W
Pivot	↻

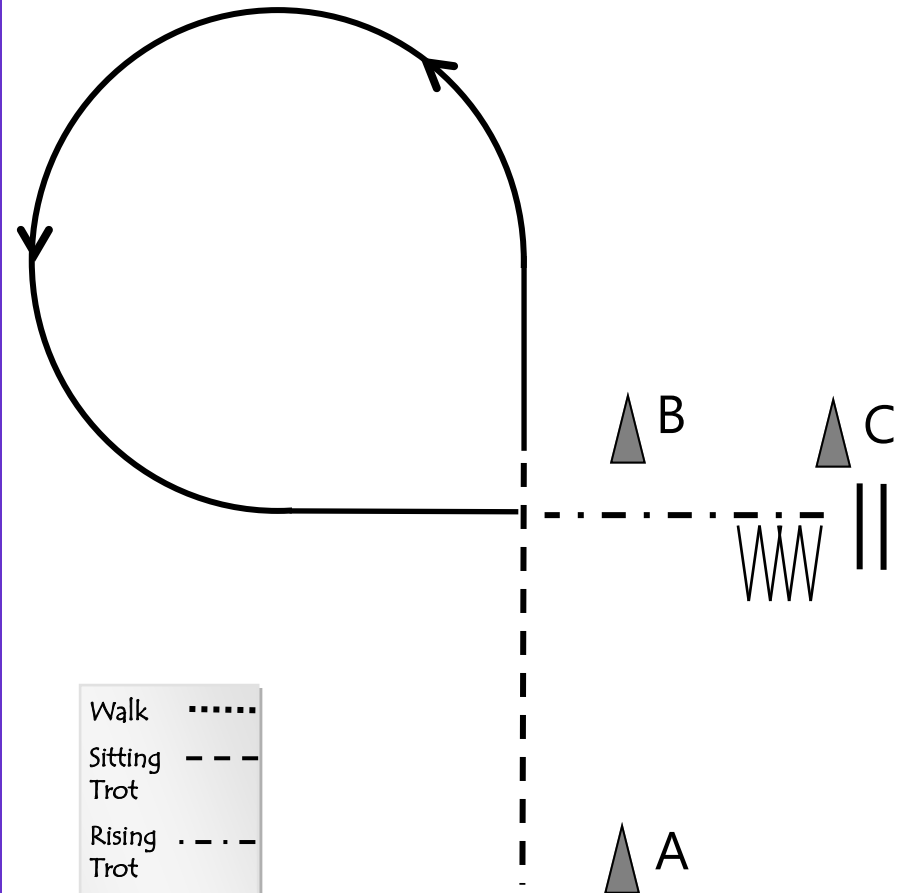

1. Start at **A**
2. Sitting Trot to **B**
3. Canter Left circle back to **B**
4. Rising Trot to **C**
5. Halt
6. Back 5 steps

# English Equitation Int

Reviewed 3/22/2018

## Pattern #241

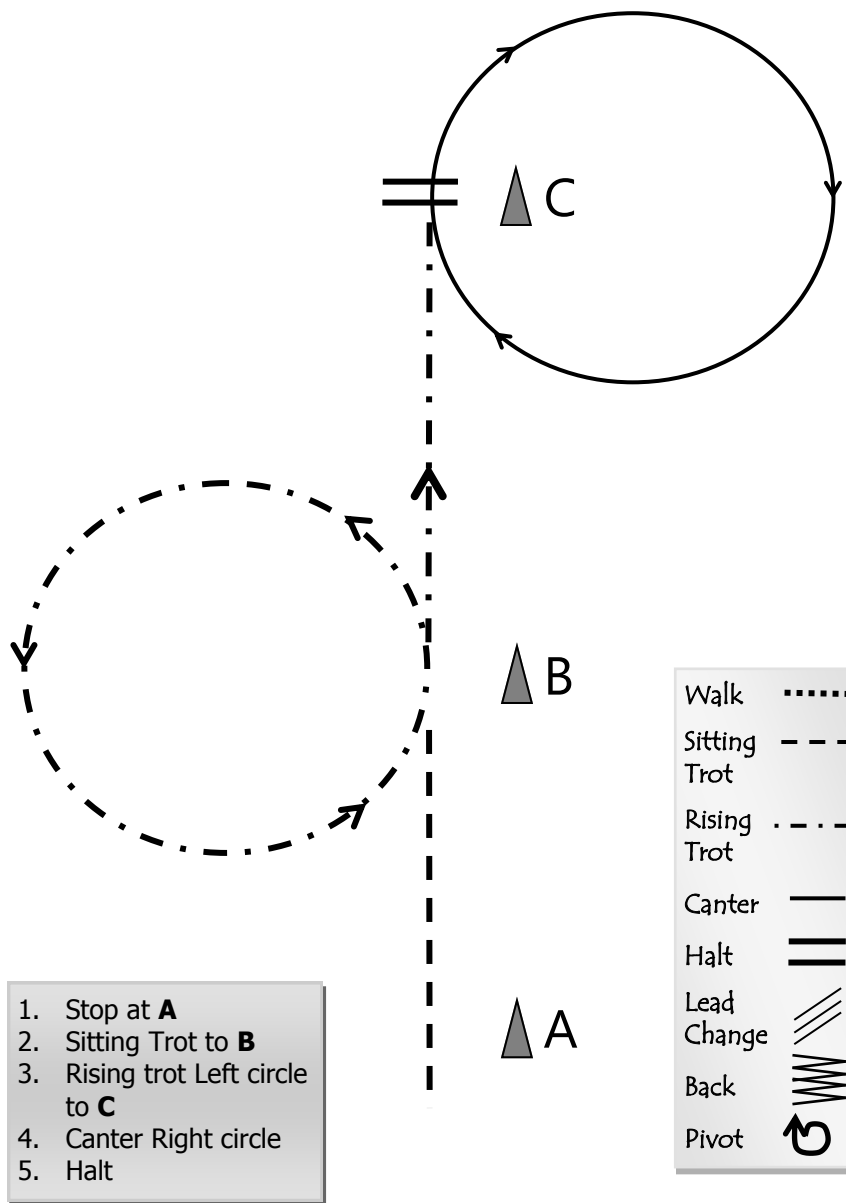

# English Equitation Int

Reviewed 3/22/2018

## Pattern #242

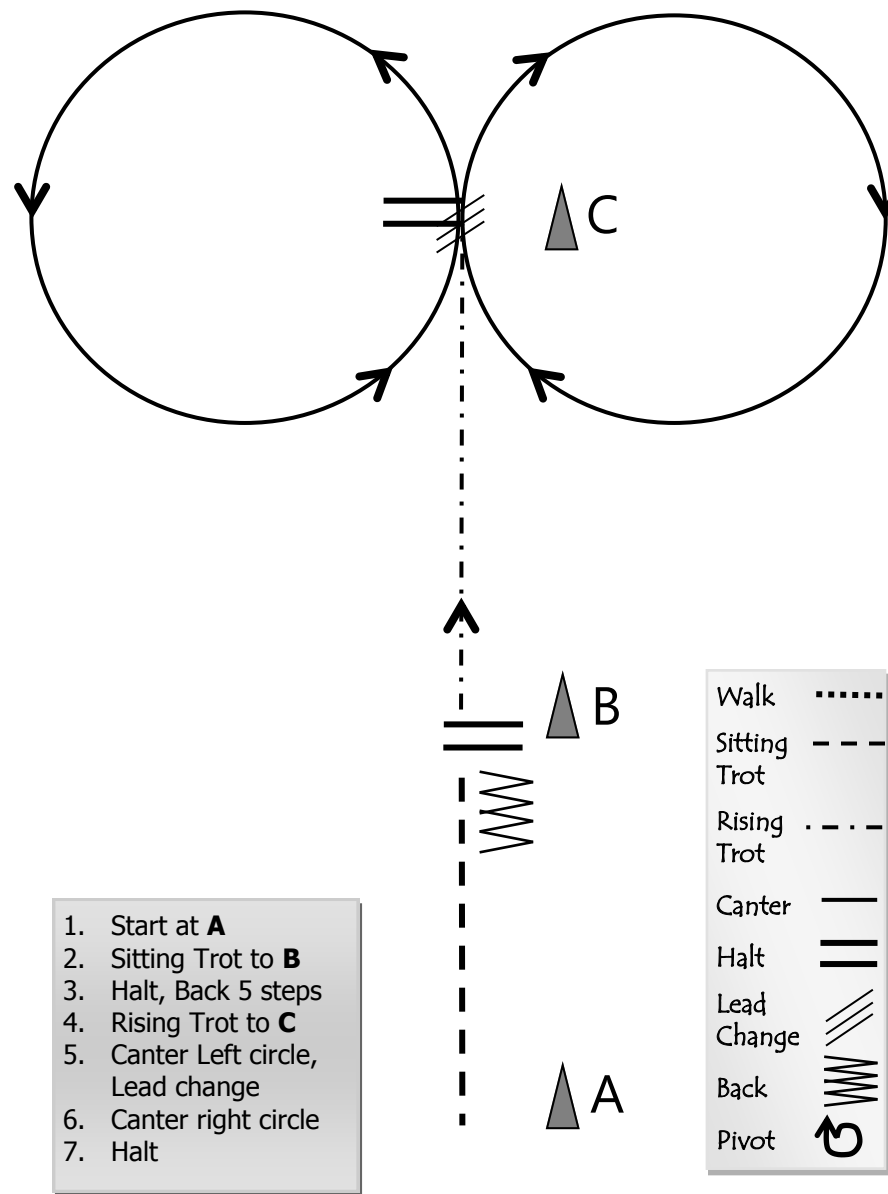

# English Equitation Int

Reviewed 3/22/2018

## Pattern #243

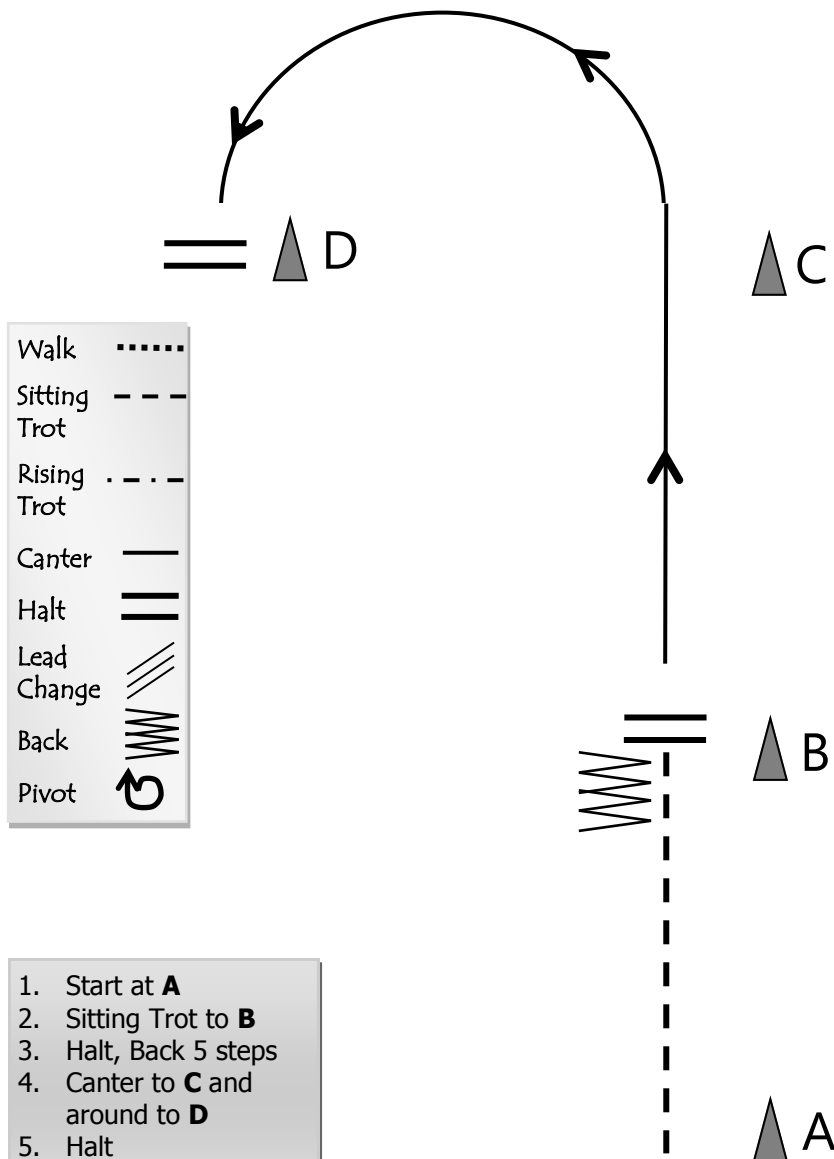

1. Start at **A**
2. Sitting Trot to **B**
3. Halt, Back 5 steps
4. Canter to **C** and around to **D**
5. Halt

Walk	.....
Sitting Trot	- - - -
Rising Trot	. . . .
Canter	—
Halt	
Lead Change	///
Back	W
Pivot	↻

# English Equitation Int

Reviewed 3/22/2018

## Pattern #244

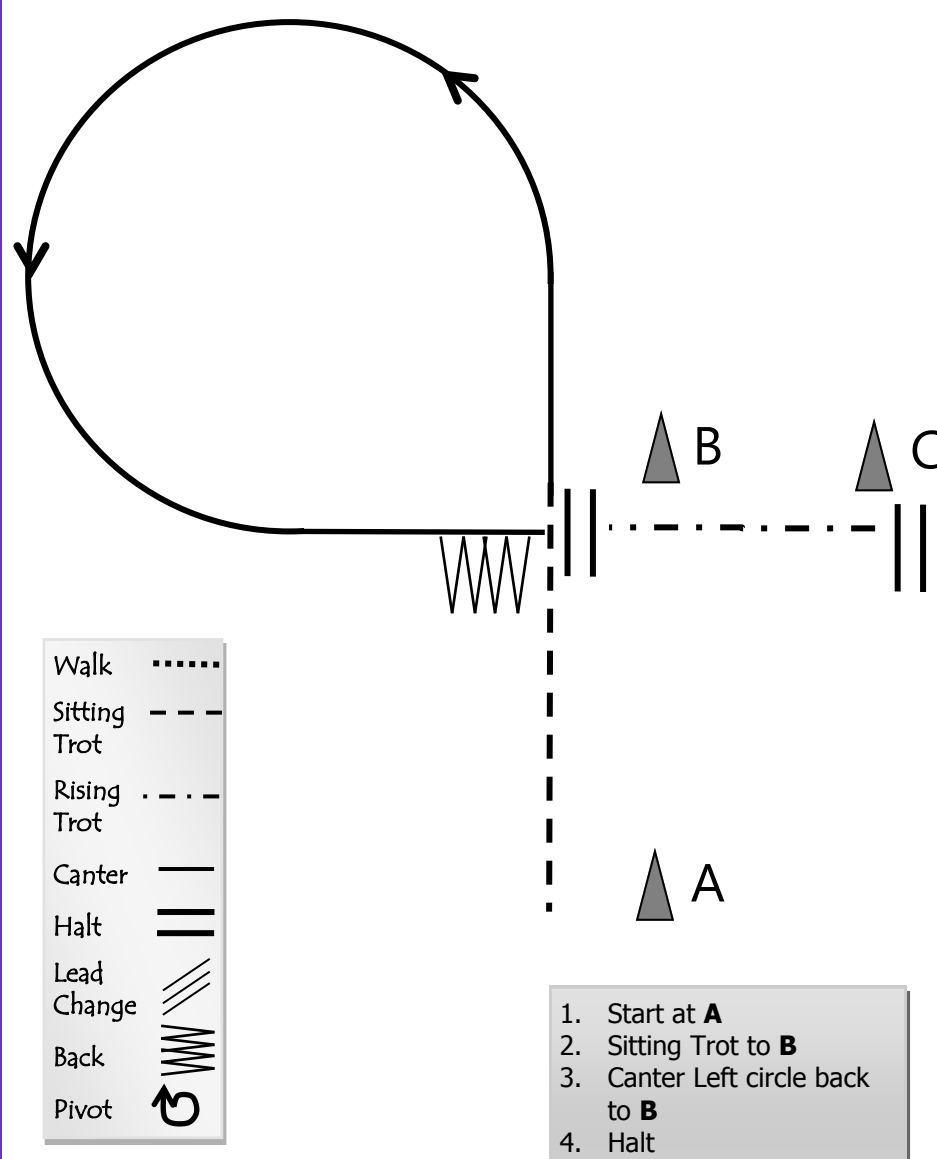

1. Start at **A**
2. Sitting Trot to **B**
3. Canter Left circle back to **B**
4. Halt
5. Back 5 steps
6. Rising Trot to **C**
7. Halt

Walk	.....
Sitting Trot	- - - -
Rising Trot	. . . .
Canter	—
Halt	
Lead Change	///
Back	W
Pivot	↻

# English Equitation sr

Reviewed 3/22/2018

## Pattern #341

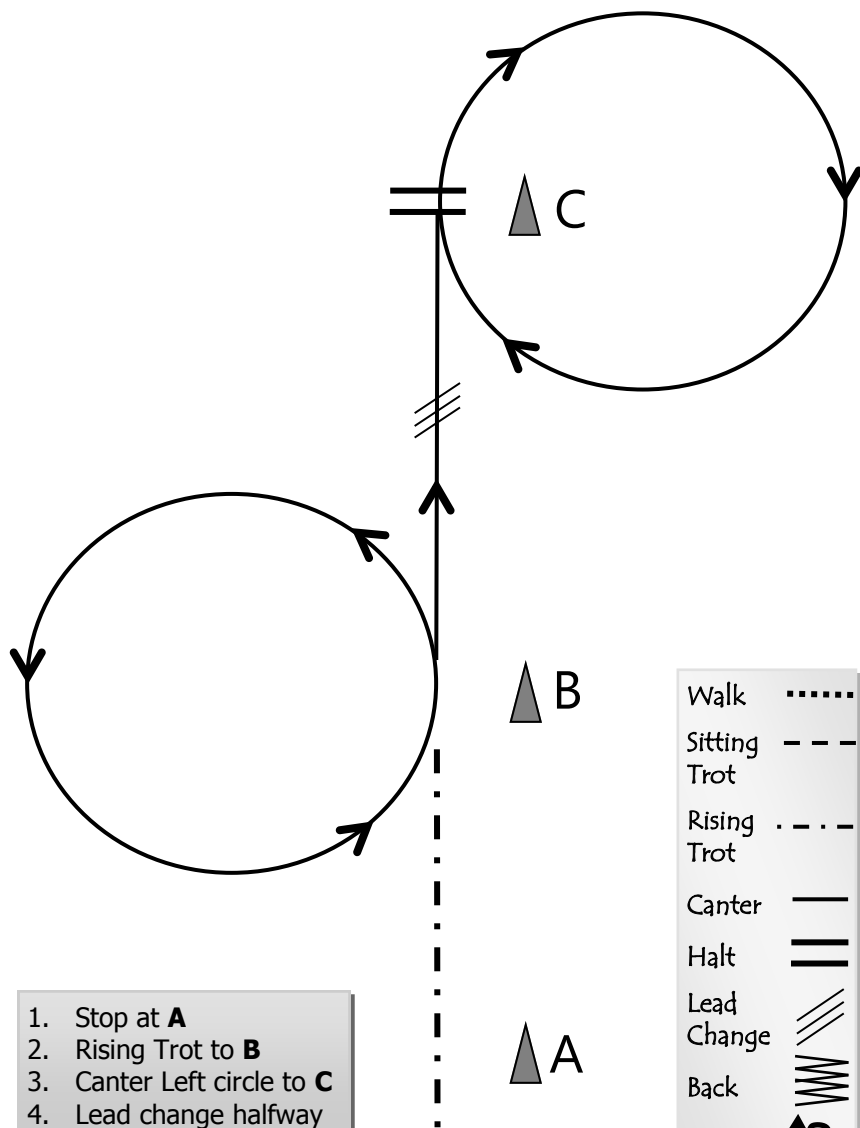

1. Stop at **A**
2. Rising Trot to **B**
3. Canter Left circle to **C**
4. Lead change halfway to **C**
5. Canter right circle
6. Halt

Walk	.....
Sitting Trot	---
Rising Trot	.-.-.-
Canter	—
Halt	
Lead Change	////
Back	W
Pivot	↻

# English Equitation sr

Reviewed 3/22/2018

## Pattern #342

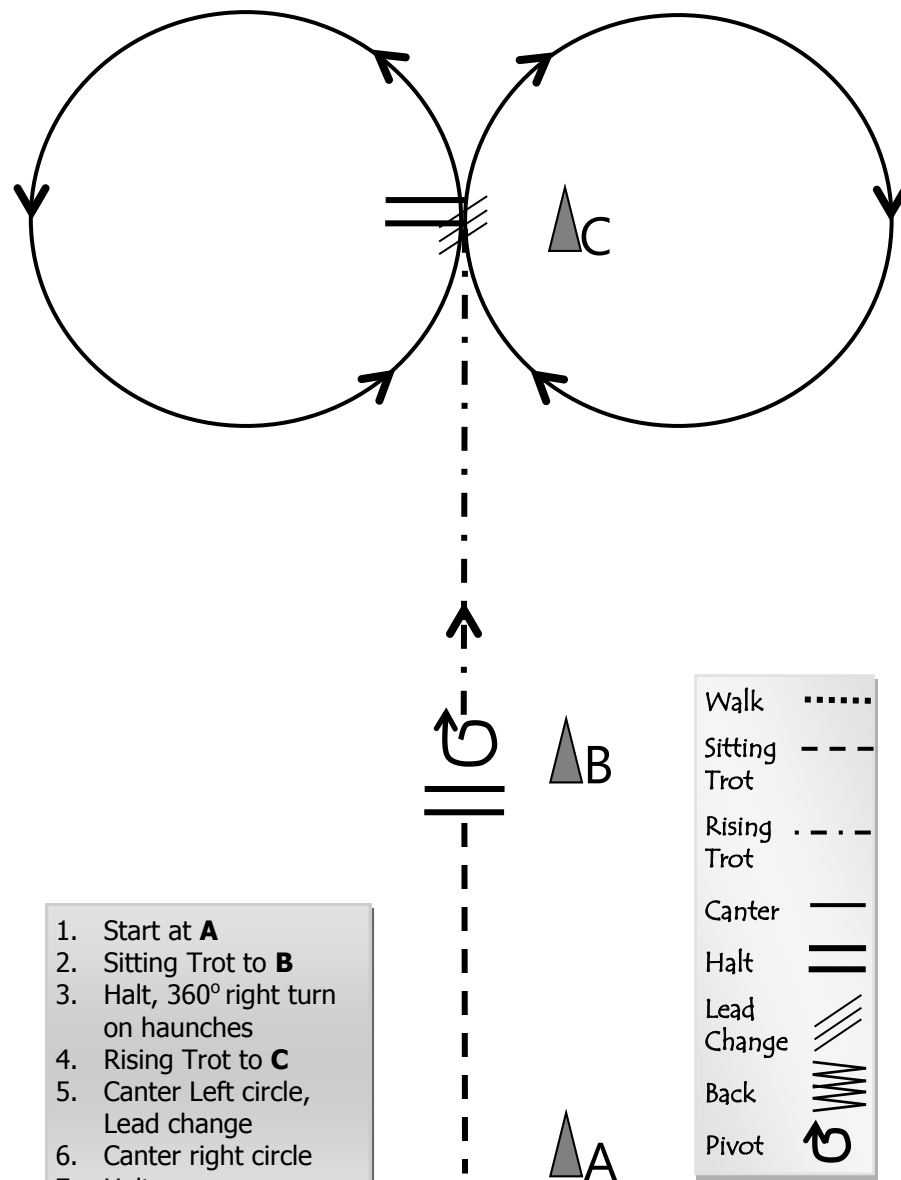

1. Start at **A**
2. Sitting Trot to **B**
3. Halt, 360° right turn on haunches
4. Rising Trot to **C**
5. Canter Left circle, Lead change
6. Canter right circle
7. Halt

Walk	.....
Sitting Trot	---
Rising Trot	.-.-.-
Canter	—
Halt	
Lead Change	////
Back	W
Pivot	↻





# English Equitation Over Fences

Ground Poles  
Level I (18" max height)  
Cross Rails Only

Reviewed 3/22/2018

## Pattern #551

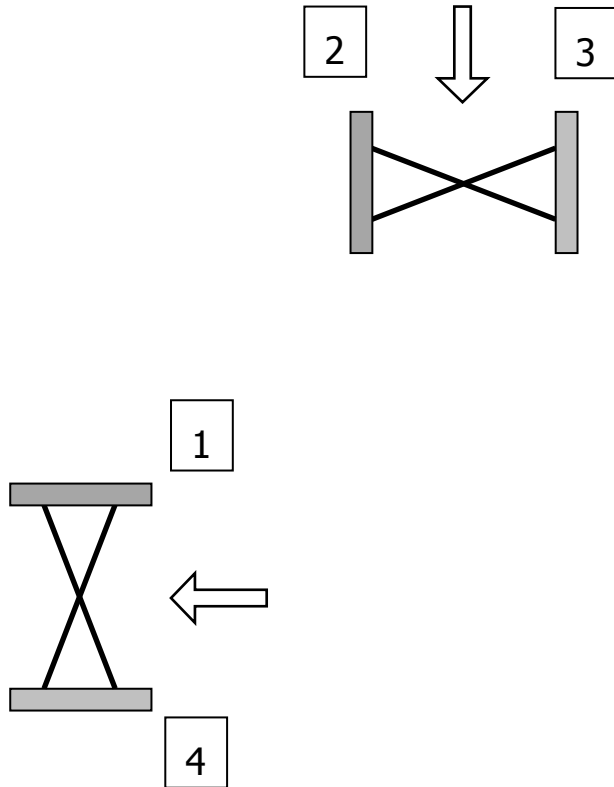

Complete a courtesy circle and then the jumping course  
(may trot or canter fences)

# English Equitation Over Fences

Ground Poles  
Level I (18" max height)  
Cross Rails Only

Reviewed 3/22/2018

## Pattern #552

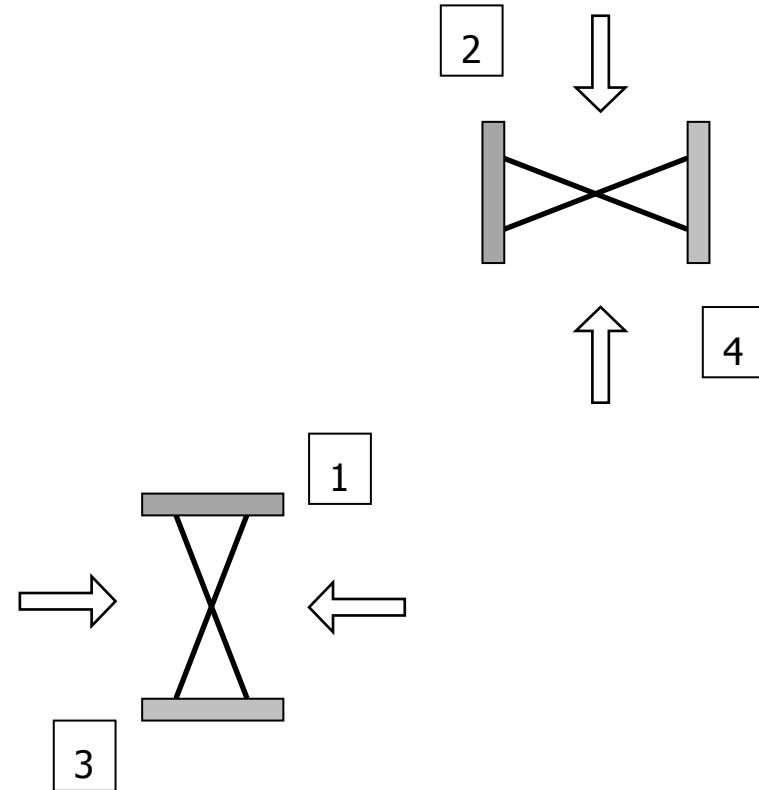

Complete a courtesy circle and then the jumping course  
(may trot or canter fences)

# English Equitation Over Fences

Reviewed 3/22/2018

## Pattern #561

- Level II (2' max height)  
1-Cross Rail & 1 Vertical
- Level III (2'3" max height)  
2 Verticals
- Level IV (2'6" max height)  
2 Verticals

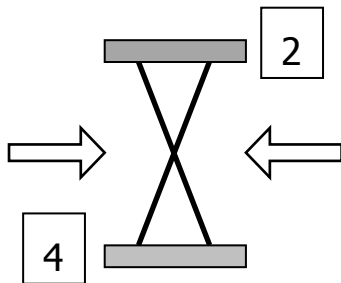
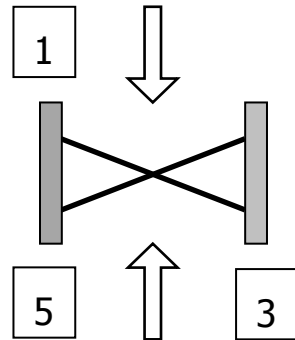

Complete a courtesy circle and then the jumping course  
(Level II may trot or canter fences, Level III & IV must canter fences )

# English Equitation Over Fences

Reviewed 3/22/2018

## Pattern #562

- Level II (2' max height)  
1-Cross Rail & 1 Vertical
- Level III (2'3" max height)  
2 Verticals
- Level IV (2'6" max height)  
2 Verticals

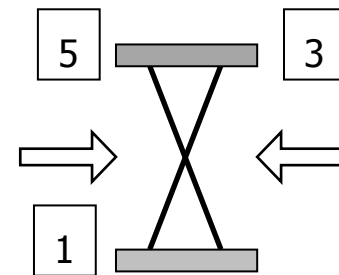
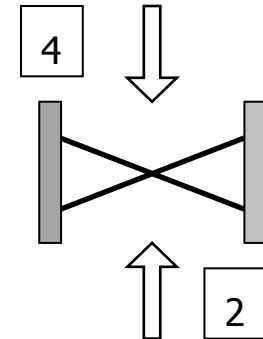

Complete a courtesy circle and then the jumping course  
(Level II may trot or canter fences, Level III & IV must canter fences )



# Western Riding Int/Sr

Reviewed 3/22/2018

Pattern #773

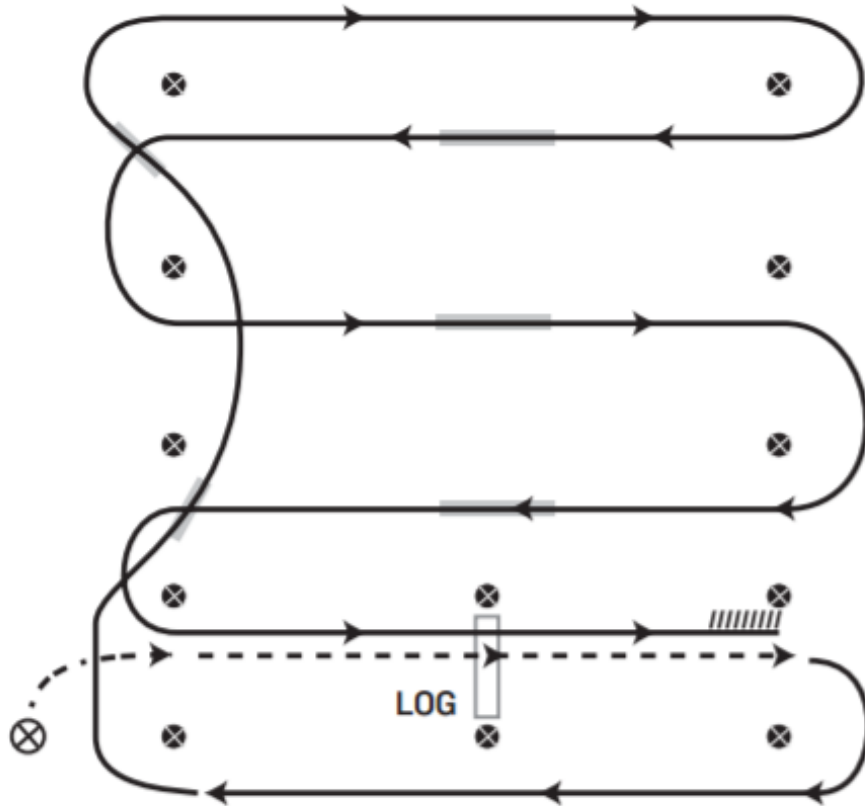

1. Walk, transition to jog, jog over log
2. Transition to right lead & lope around end
3. First line change
4. Second line change, lope around end of arena
5. First crossing change
6. Second crossing change
7. Third crossing change
8. Lope over log
9. Lope, stop & back

# Western Riding Int/Sr

Reviewed 3/22/2018

Pattern #

# Western Riding Int/Sr

Reviewed 3/22/2018

## Pattern #781

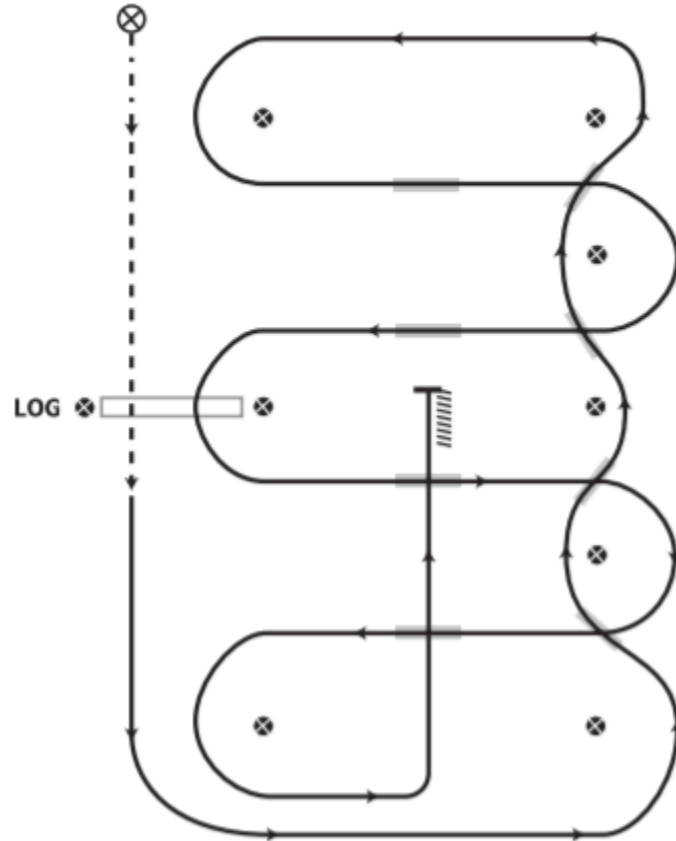

1. Walk at least 15' & jog over log
2. Transition to left lead & lope around end
3. First line change
4. Second line change
5. Third line change
6. Fourth line change, lope around end of arena
7. First crossing change
8. Second crossing change
9. Lope over log
10. Third crossing change
11. Fourth crossing change
12. Lope up center, stop & back

# Western Riding Int/Sr

Reviewed 3/22/2018

## Pattern #782

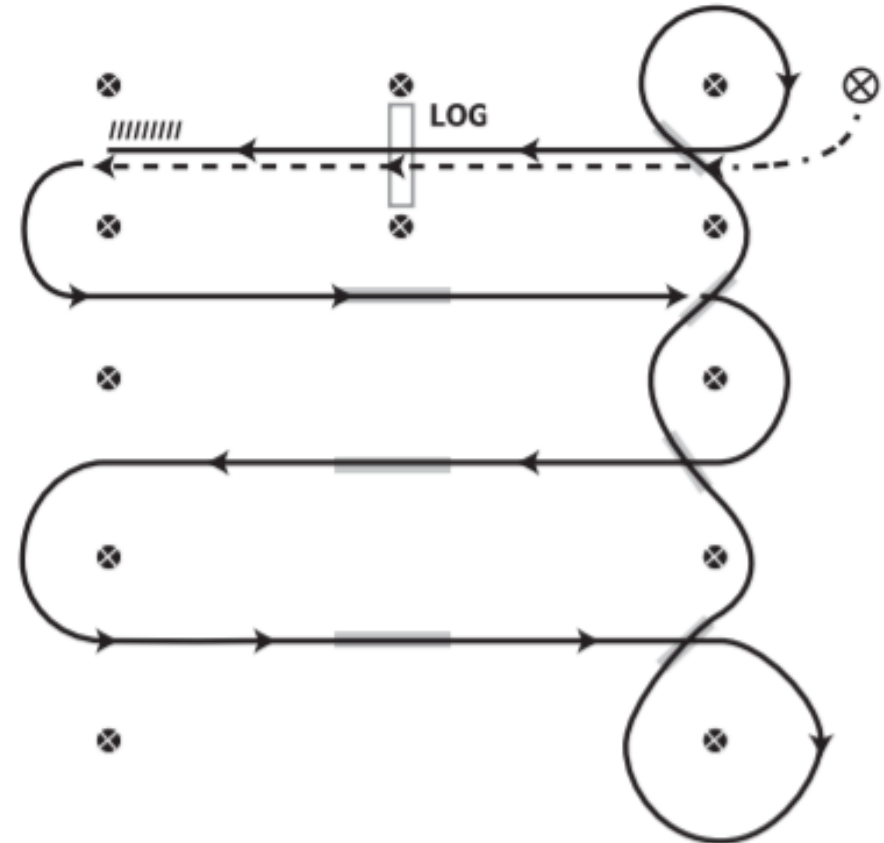

1. Walk, transition to jog, jog over log
2. Transition to lope, on the left lead
3. First crossing change
4. Second crossing change
5. Third crossing change
6. Circle & first line change
7. Second line change
8. Third line change
9. Fourth line change & circle
10. Lope over log
11. Lope, stop & back

# Western Riding Int/Sr

Reviewed 3/22/2018

## Pattern #783

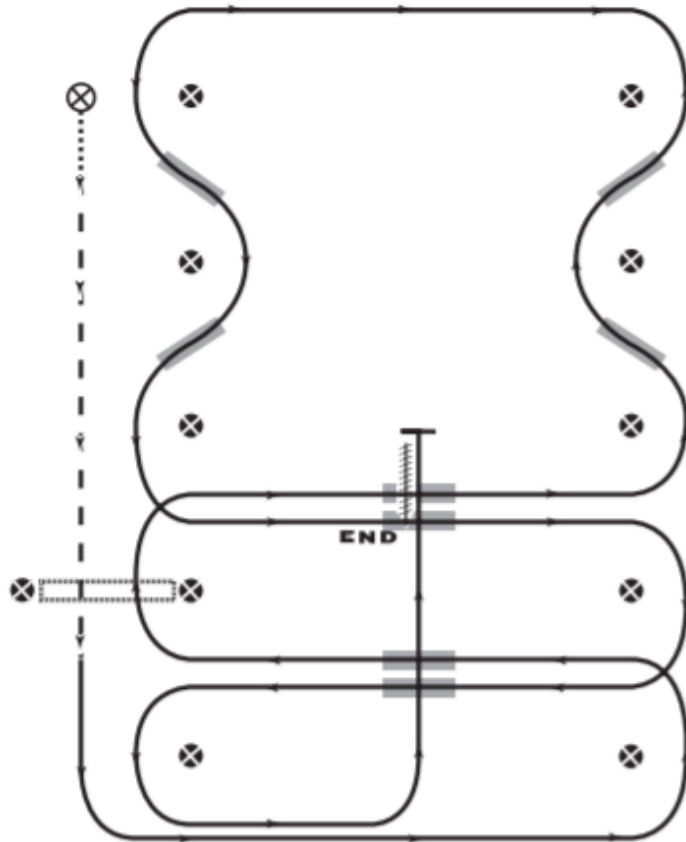

⊗ START CONE  
 WALK - - - - -  
 JOG - - - - -  
 LOPE - - - - -  
 LEAD CHANGING AREA [shaded box]

1. Walk halfway between markers, transition to jog, jog over log
2. Transition to the lope, on the left lead
3. First crossing change
4. Lope over log
5. Second crossing change
6. First line change
7. Second line change
8. Third line change
9. Fourth line change
10. Third crossing change
11. Fourth crossing change
12. Lope up the center, stop & back

# Western Riding Int/Sr

Reviewed 3/22/2018

## Pattern #784

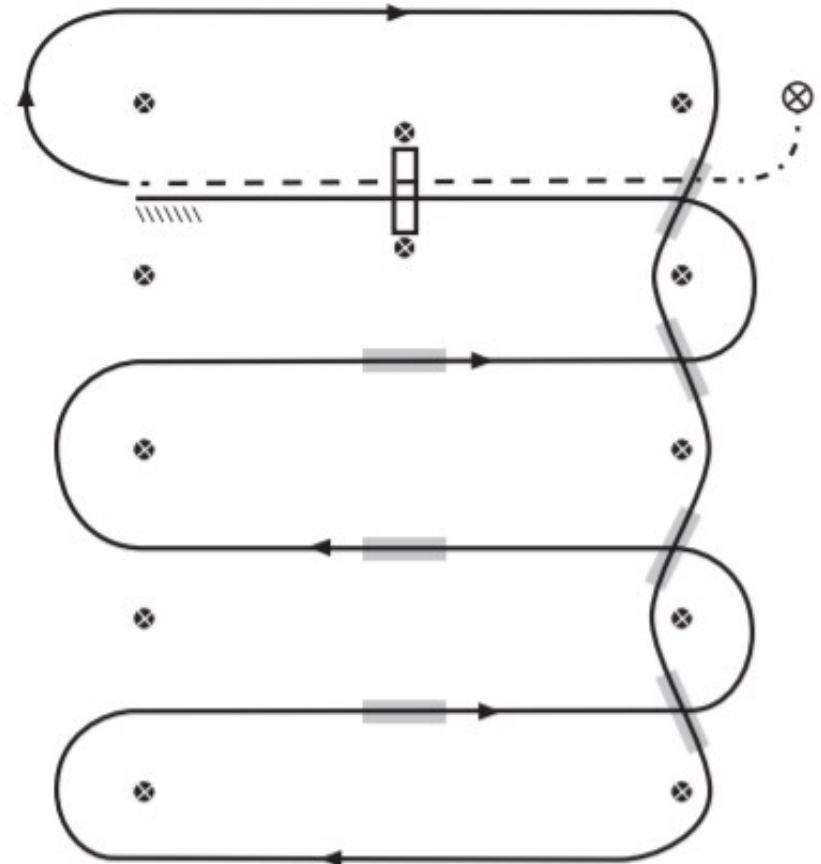

⊗ START CONE  
 WALK - - - - -  
 JOG - - - - -  
 LOPE - - - - -  
 LEAD CHANGING AREA [shaded box]

1. Walk, transition to jog, jog over log
2. Transition to lope, on the right lead
3. First line change
4. Second line change
5. Third line change
6. Fourth line change
7. First crossing change
8. Second line change
9. Third line change & circle
10. Lope over log
11. Lope, stop & back

# Western Horsemanship Walk-Jog

Reviewed 3/22/2018

## Pattern #411

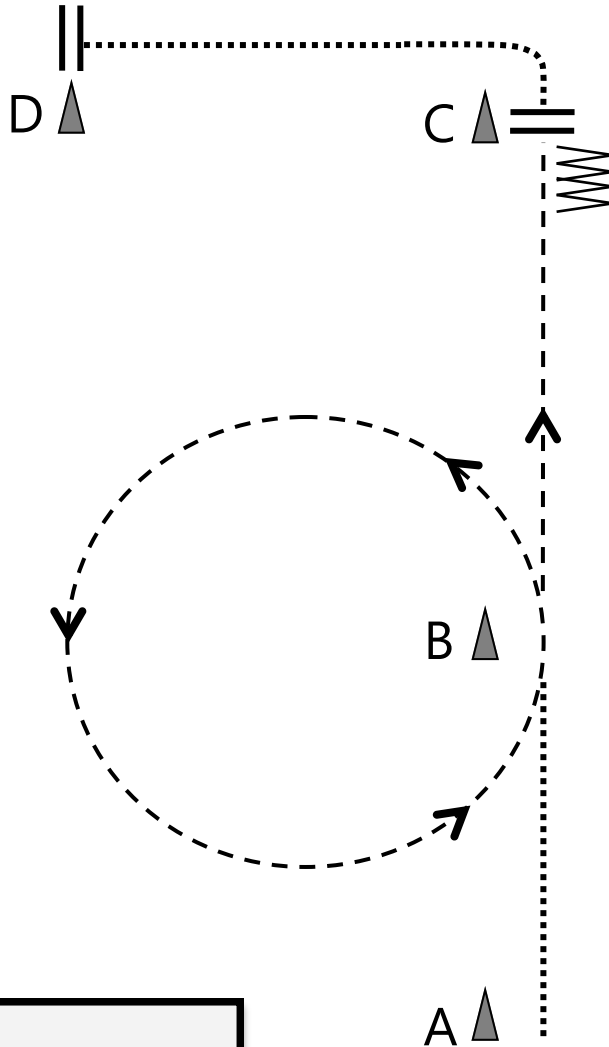

Walk	.....
Jog	- - -
Lope	—
Stop	≡
Back	⋈
Extended Jog	- . -
Side-Pass	⇒
Lead Change	≡

1. Stop at **A**
2. Walk to **B**
3. Jog Left circle around B, continue to **C**
4. Stop
5. Back 5 steps
6. Walk around **C** to **D**
7. Stop

# Western Horsemanship Walk-Jog

Reviewed 3/22/2018

## Pattern #413

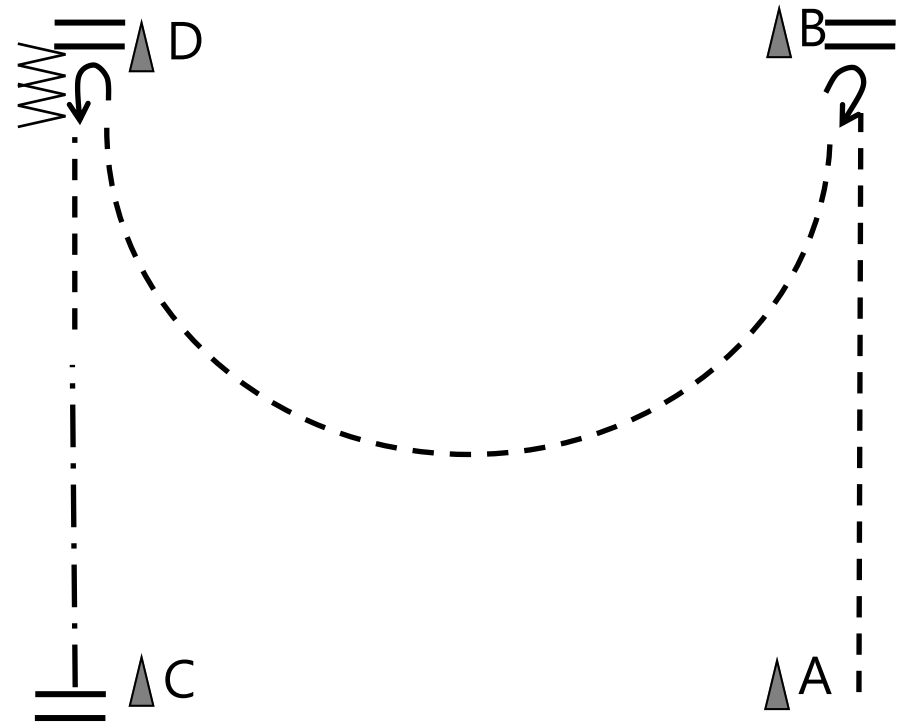

1. Stop at **A**
2. Jog to **B**
3. Stop
4. Right pivot 180°
5. Jog 1/2 circle to **D**
6. Stop
7. Left pivot 180°
8. Back 5 steps
9. Jog halfway to **C**, Extended jog to **C**
10. Stop

Walk	.....	Extended	- . -
Jog	- - -	Jog	- - -
Lope	—	Side-Pass	⇒
Stop	≡	Lead Change	≡
Back	⋈		

# Western Horsemanship Walk-Jog

Reviewed 3/22/2018

## Pattern #412

Reviewed 3/22/2018

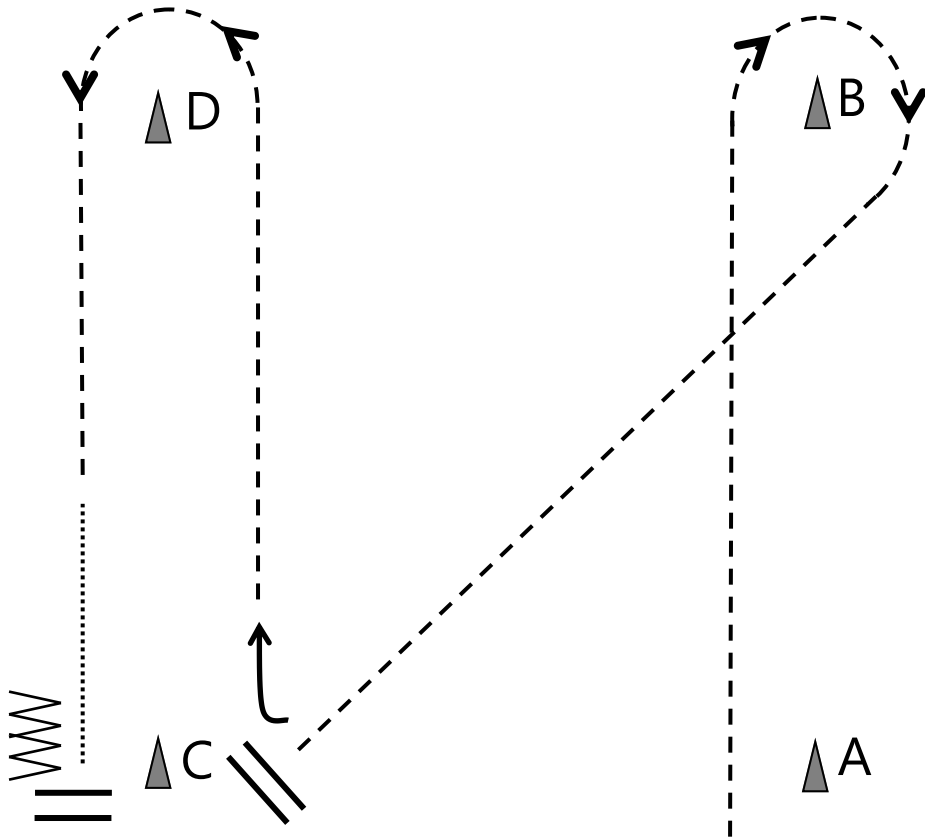

1. Stop at **A**
2. Jog to and around **B** to **C**
3. Stop
4. Right pivot 45°
5. Jog around **D**
6. Halfway to **C**, break to walk.
7. At **C**, Stop
8. Back 5 steps

Walk	.....	Extended	- . - -
Jog	- - -	Jog	- . - -
Lope	—	Side-Pass	⇒⇒
Stop	≡	Lead	///
Back	≡≡≡	Change	///



# Western Horsemanship Jr

## Pattern #113

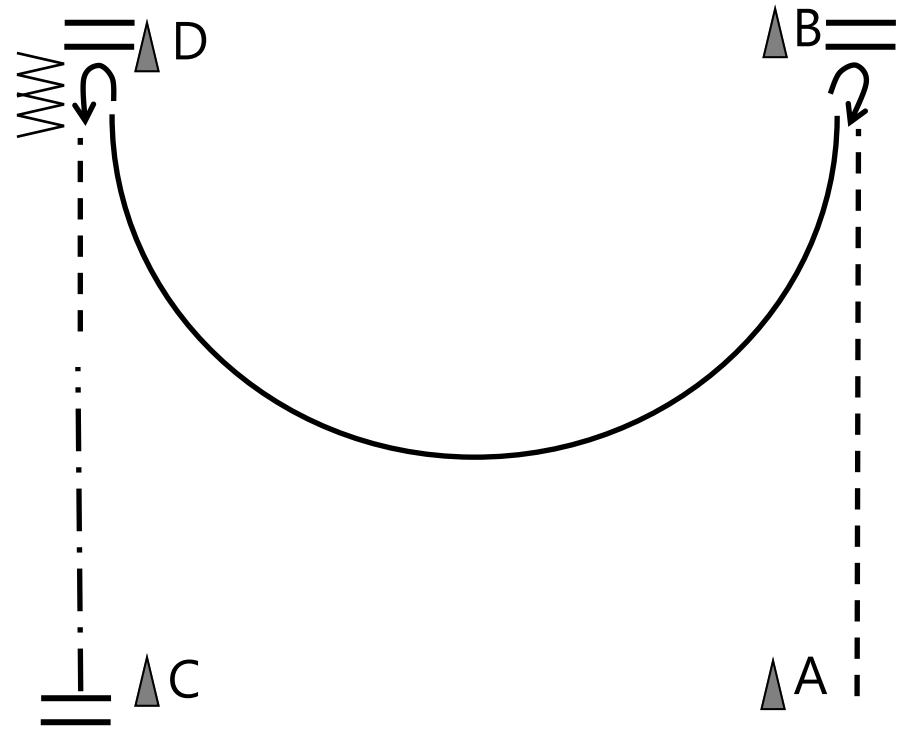

1. Stop at **A**
2. Jog to **B**
3. Stop
4. Right pivot 180°
5. Lope right lead 1/2 circle to **D**
6. Stop
7. Left pivot 180°
8. Back 5 steps
9. Jog halfway to **C**, Extended Jog to **C**
10. Stop

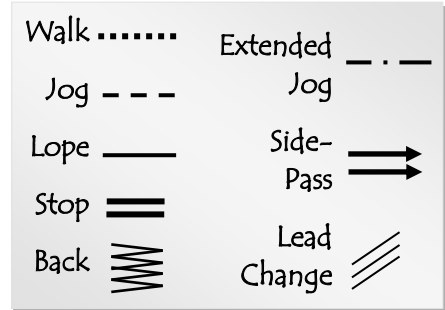

# Western Horsemanship Jr

Reviewed 3/22/2018

## Pattern #111

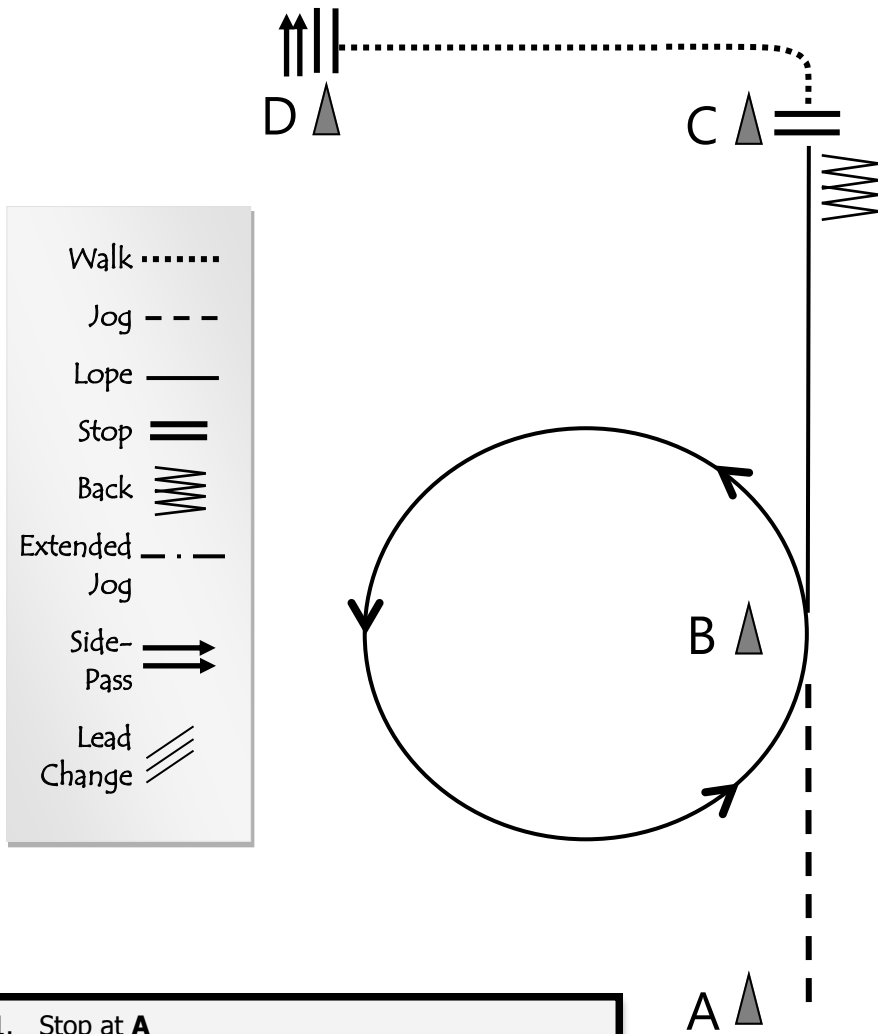

1. Stop at **A**
2. Jog to **B**
3. Lope Left lead circle around **B**, continue to **C**.
4. Stop
5. Back 5 steps
6. Walk around **C** to **D**
7. Stop
8. Side-Pass right

Walk	.....
Jog	---
Lope	—
Stop	==
Back	≡
Extended Jog	- . -
Side-Pass	⇒
Lead Change	≡

# Western Horsemanship Jr

Reviewed 3/22/2018

## Pattern #112

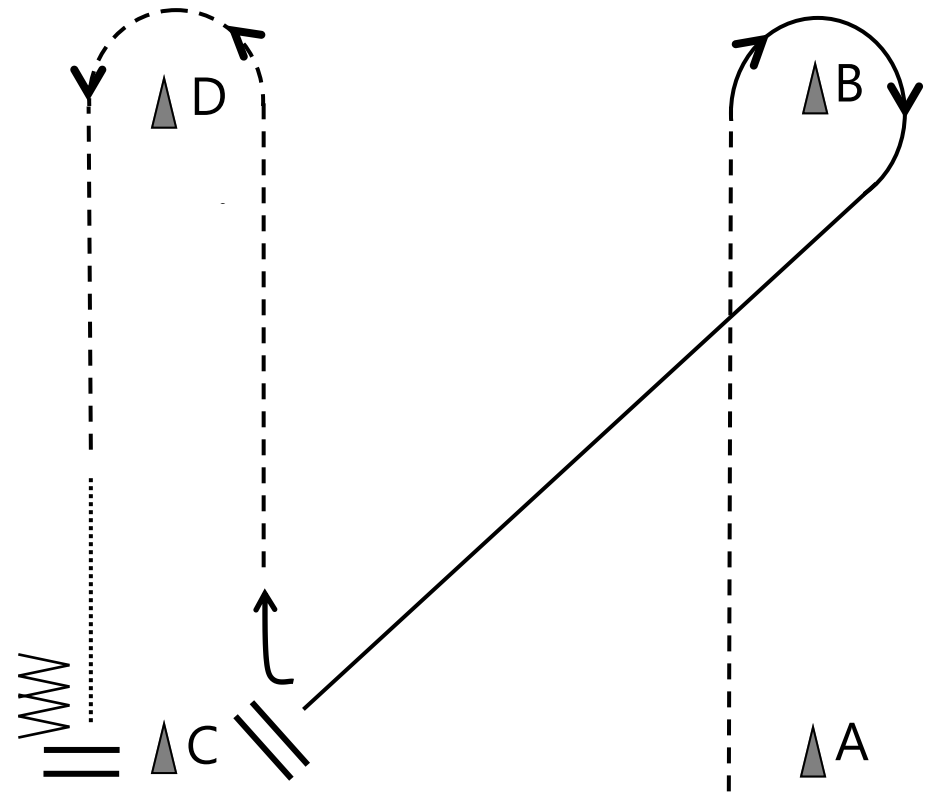

1. Stop at **A**
2. Jog to **B**
3. Lope Right lead around **B** to **C**
4. Stop
5. Right pivot 45°
6. Jog around **D**
7. Halfway to **C**, break to walk.
8. At **C**, Stop
9. Back 5 steps

Walk	.....	Extended Jog	- . -
Jog	---	Side-Pass	⇒
Lope	—	Lead Change	≡
Stop	==		
Back	≡		

# Western Horsemanship Int.

Reviewed 3/22/2018

## Pattern #211

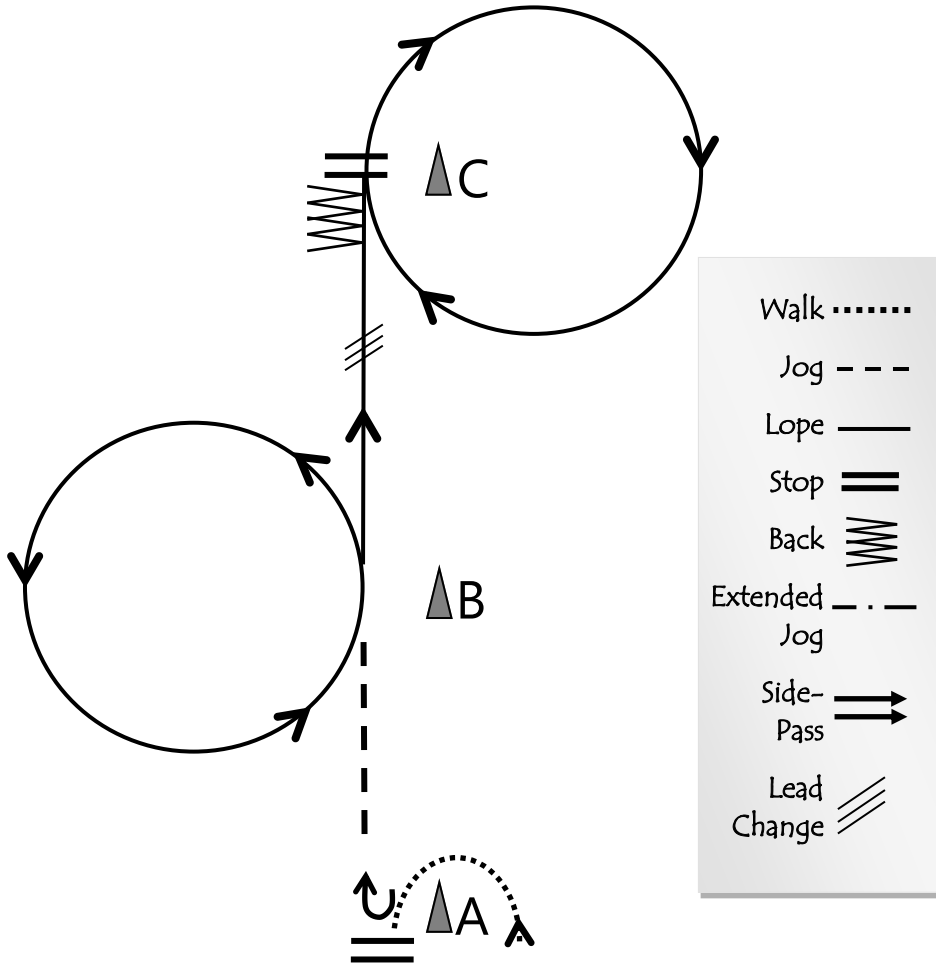

Walk	.....
Jog	---
Lope	—
Stop	≡
Back	⋈
Extended Jog	- . -
Side-Pass	⇨
Lead Change	⧘

1. Stop at **A**, walk around **A**, Stop
2. 180° pivot right.
3. Jog to **B**
4. Lope Left lead Circle, continue toward **C**
5. Lead change (Simple or flying) between **B & C**
6. At **C**, Lope Right lead circle.
7. Stop
8. Back 5 steps

# Western Horsemanship Int

Reviewed 3/22/2018

## Pattern #212

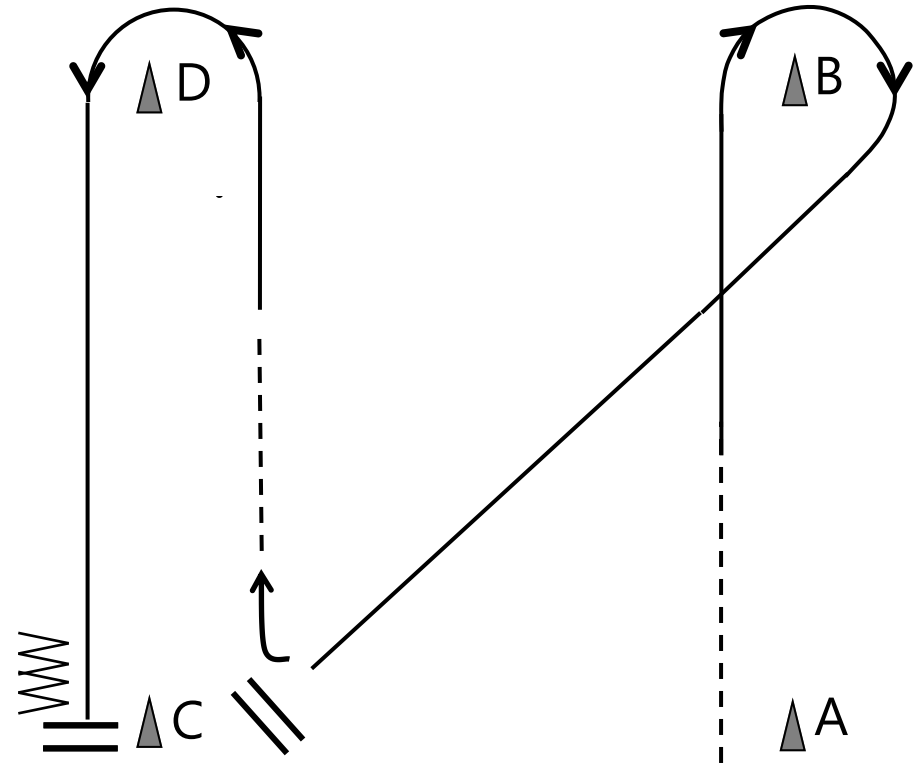

1. Stop at **A**
2. Jog halfway to **B**, begin right lead lope
3. Lope around **B to C**
4. Stop
5. Right pivot 45°
6. Jog halfway to **D**.
7. Lope Left lead around **D** to **C**
8. Stop, Back 5 steps

Walk	.....	Extended	- . -
Jog	---	Jog	---
Lope	—	Side-Pass	⇨
Stop	≡	Lead Change	⧘
Back	⋈		

# Western Horsemanship Int

Reviewed 3/22/2018

## Pattern #213

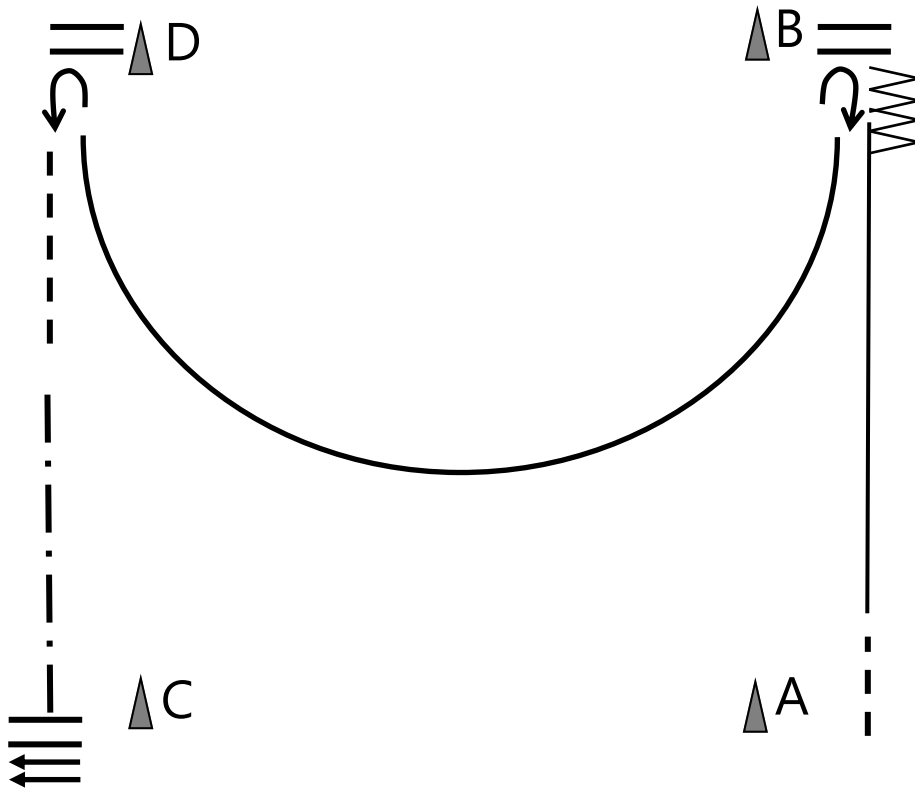

1. Stop at **A**
2. Jog a few steps, then Lope Left lead to **B**
3. Stop
4. Back 5 steps
5. Right pivot 180°
6. Lope right lead 1/2 circle to **D**
7. Stop
8. Left pivot 180°
9. Jog halfway to **C**, Extended Jog to **C**
10. Stop
11. Side Pass right

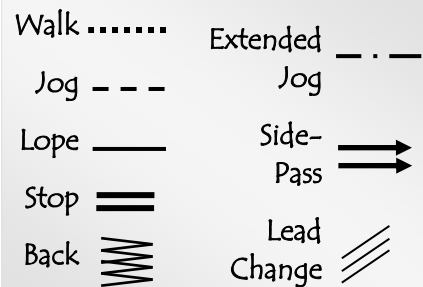

# Western Horsemanship Int

Reviewed 3/22/2018

## Pattern #214

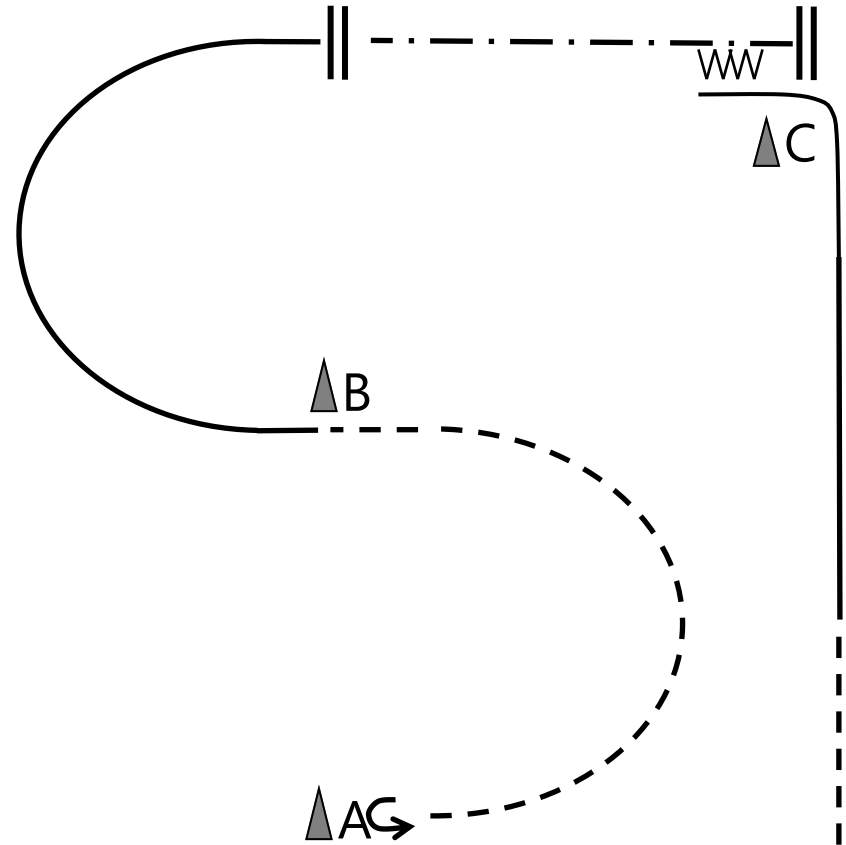

1. Start facing **A**
  2. Perform 180° turn to left
  3. Jog half circle to **B**
  4. Lope right lead circle until in line with **B**.
  5. Stop
  6. Extend the jog to **C**
  7. Stop, back.
  8. Lope a square corner around **C**, then jog.
- Pattern is complete, exit at a jog.

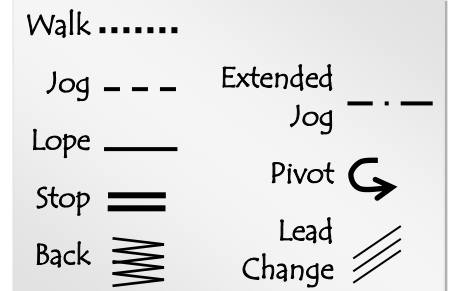

# Western Horsemanship sr.

Reviewed 3/22/2018

## Pattern #311

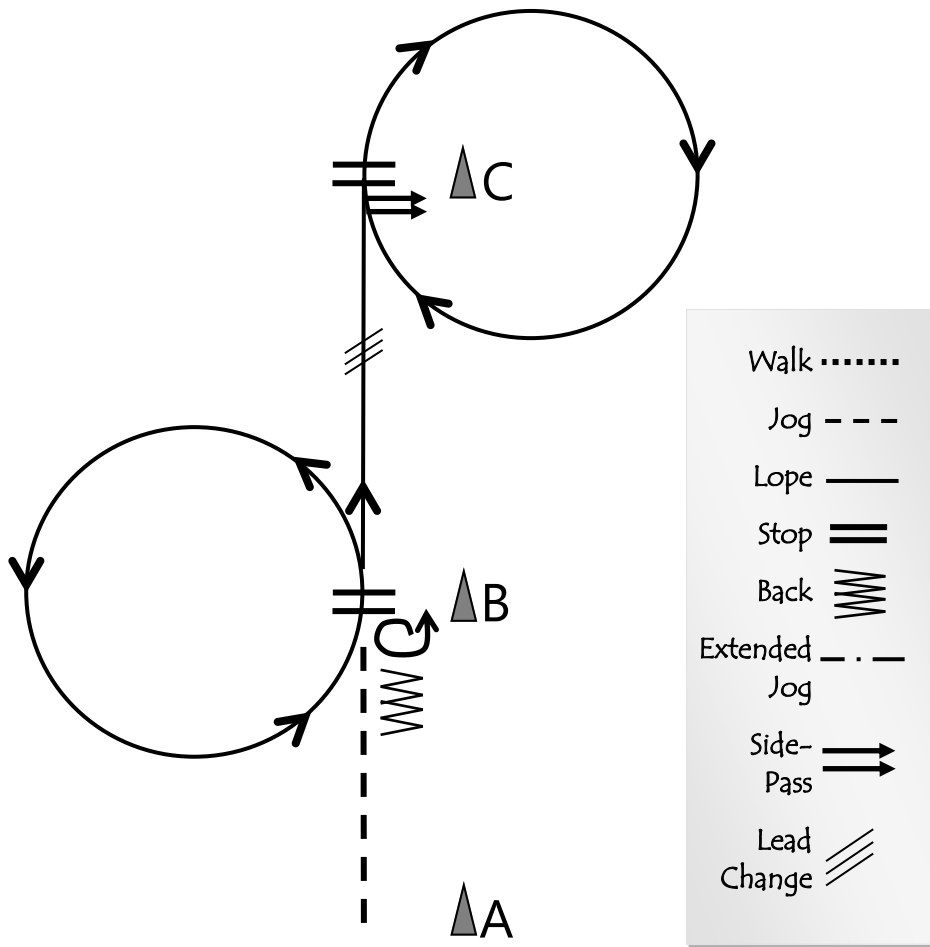

Walk	.....
Jog	---
Lope	—
Stop	≡
Back	≡≡≡
Extended Jog	-.-.-
Side-Pass	⇒⇒
Lead Change	≡≡≡

1. Stop at **A**
2. Jog to **B**, stop
3. 360° pivot left
4. Back 5 steps
5. Lope Left Circle, continue toward **C**.
6. Lead change (Simple or flying) between **B & C**
7. At **C**, Lope Right circle
8. Stop
9. Side pass right.

# Western Horsemanship sr

Reviewed 3/22/2018

## Pattern #312

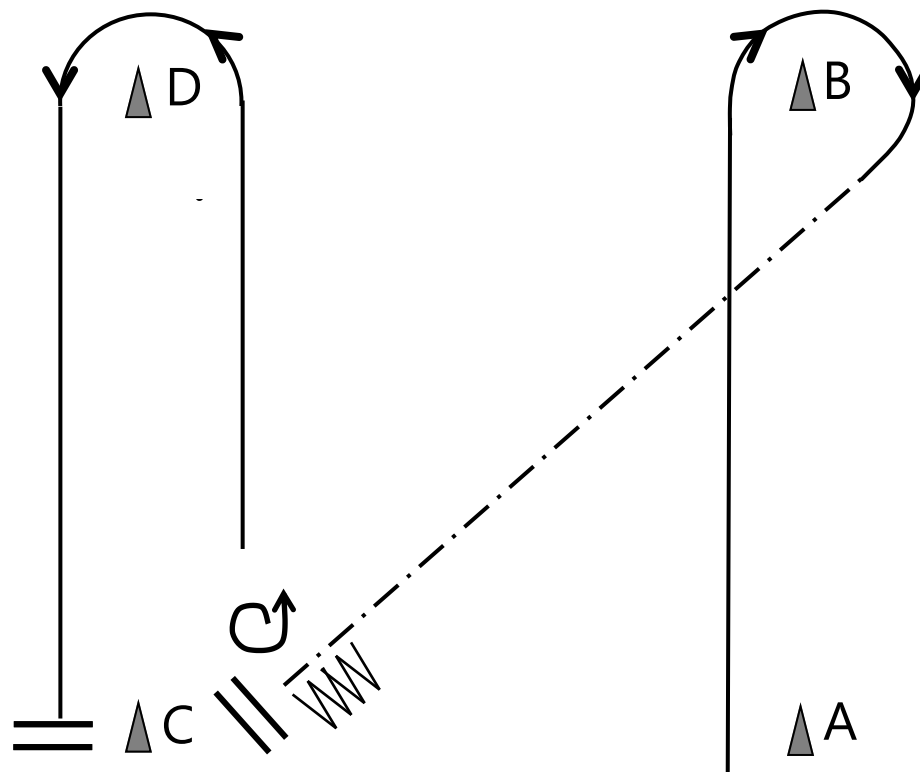

1. Stop at **A**
2. Lope right lead around **B**
3. Extended Jog to **C**
4. Stop, back 5 steps
5. Left pivot 270°
6. Lope Left lead around **D to C**
7. Stop

Walk	.....	Extended	-.-.-
Jog	---	Jog	---
Lope	—	Side-Pass	⇒⇒
Stop	≡	Lead Change	≡≡≡
Back	≡≡≡		

# Western Horsemanship sr

Reviewed 3/22/2018

## Pattern #313

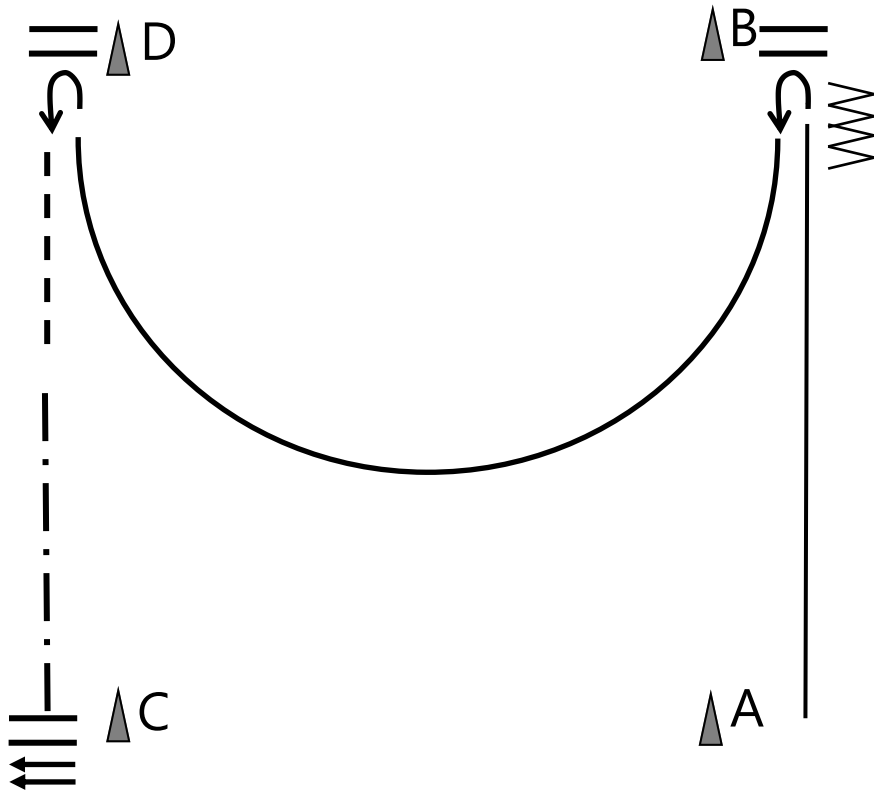

1. Stop at **A**
2. Lope Left lead to **B**
3. Stop
4. Back 5 steps
5. Left pivot 180°
6. Lope right lead 1/2 circle to **D**
7. Stop
8. Left pivot 180°
9. Jog halfway to **C**, Extended Jog to **C**
10. Stop
11. Side pass right

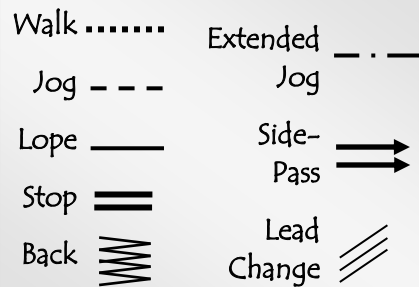

# Western Horsemanship sr

Reviewed 3/22/2018

## Pattern #314

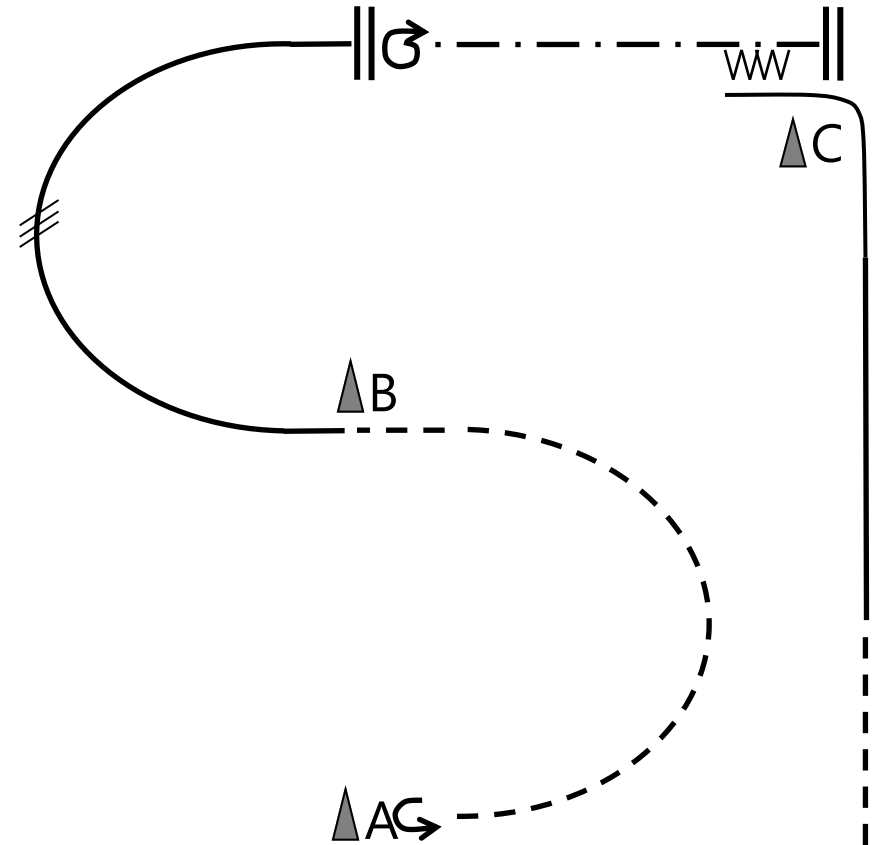

1. Start facing **A**
  2. Perform 180° turn to left
  3. Jog half circle to **B**
  4. Lope left lead circle and change leads (simple or flying)
  5. Continue circle on right lead until in line with **B**.
  6. Stop and perform 360° pivot to the right.
  7. Extend the jog to **C**
  8. Stop, Back
  9. Lope a square corner around **C**, then jog.
- Pattern is complete, exit at a jog.

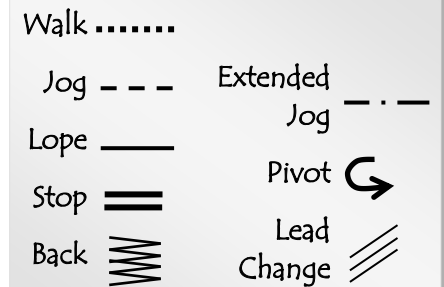

# Western Horsemanship sr

Reviewed 3/22/2018

Pattern #315

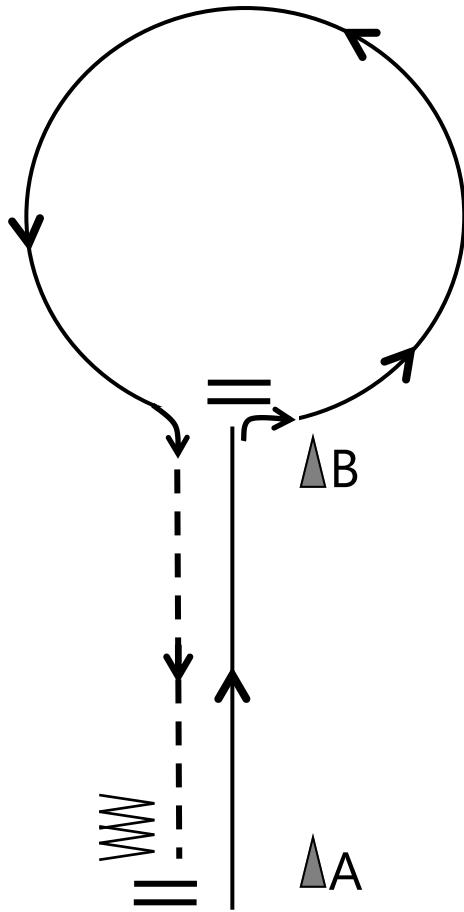

1. Start at **A**
2. Lope Right lead to **B**, Stop
3. 90<sup>0</sup> turn on haunches
4. Lope Left lead circle to **B**
5. Jog to **A**.
6. Stop, back.

Walk	.....	Extended	- . -
Jog	- - -	Jog	- . -
Lope	—	Side- Pass	⇒⇒
Stop	===	Lead	///
Back	≡≡≡	Change	///

# Western Horsemanship sr

Reviewed 3/22/2018

Pattern #

# Reining Walk-Jog

Reviewed 3/22/2018

Pattern #421

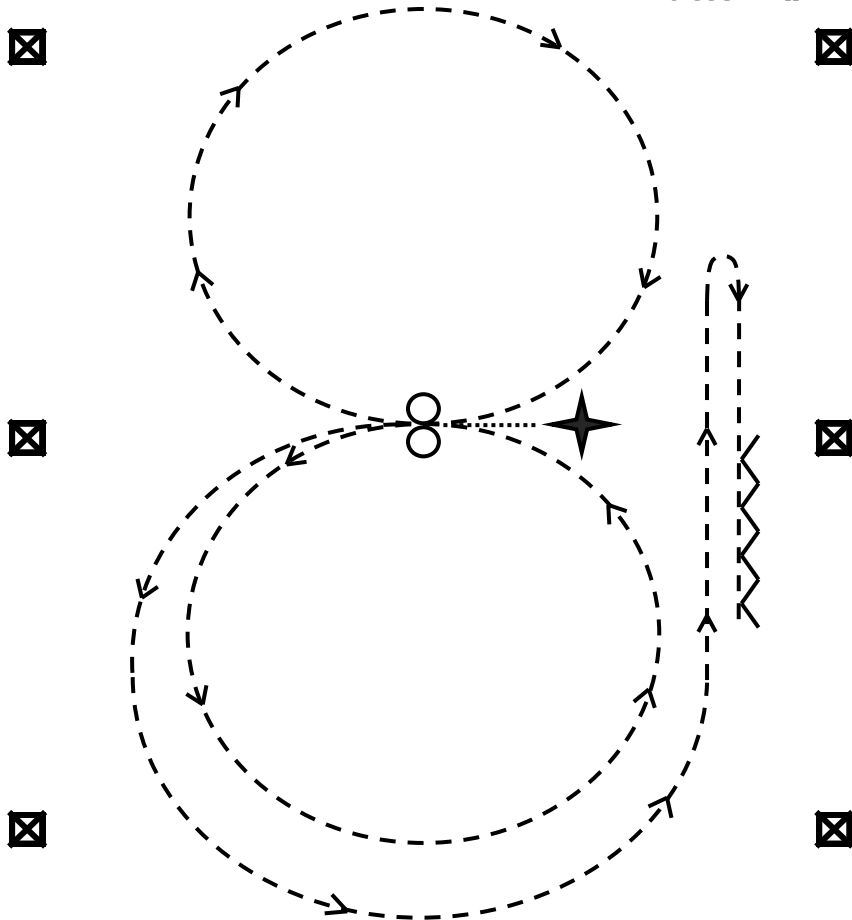

*May walk or jog to starting point*

Begin at 

1. Walk to center of arena.
2. Complete 1 large circle to the left.
3. Complete 1 large circle to the right.
4. Stop in center, 1 spin to left,
5. 1 spin to right.
6. Begin large circle to left. Do not close circle, Continue around end of arena and up side past center marker; Stop, rollback, no hesitation
7. Trot past center marker., Stop.
8. Back at least 5 steps.

Hesitate to demonstrate completion of pattern.

# Reining Walk-Jog

Reviewed 3/22/2018

Pattern # 422

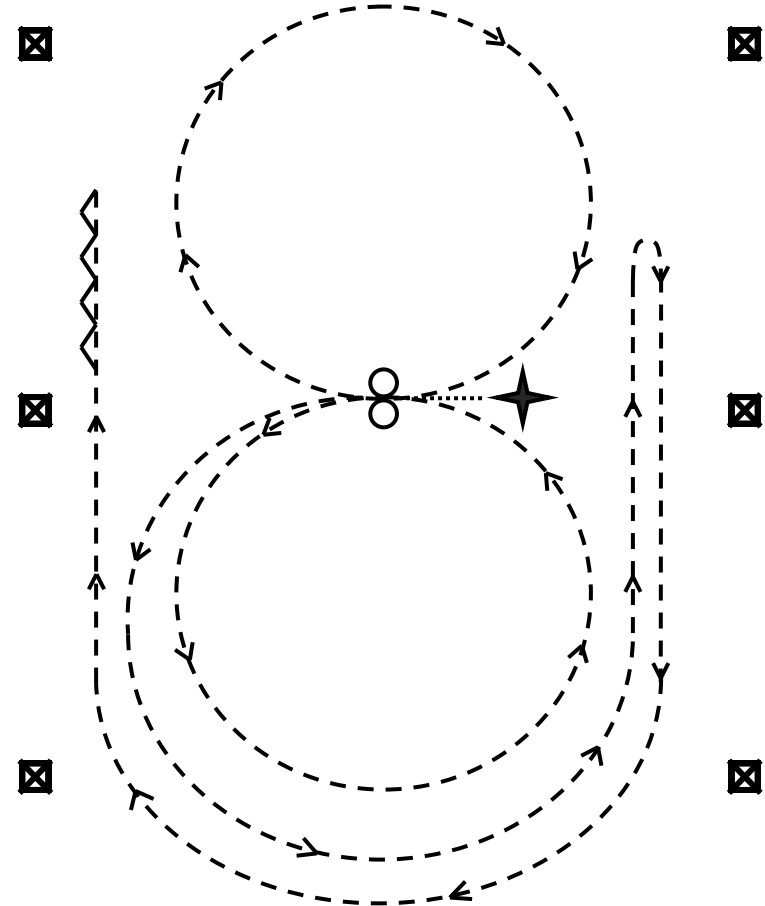

*May walk or jog to starting point*

Begin at 

1. Walk to center of arena.
2. Stop in center, 1 spin to left
3. 1 spin to right.
4. Complete 1 large circle to the left.
5. Complete 1 large circle to the right.
6. Begin large circle to left, do not close circle, continue around end of arena and up side past center marker; stop, rollback, no hesitation
7. Continue around end of arena, and up side past center marker, Stop.
8. Back at least 5 steps.

Hesitate to demonstrate completion of pattern.



# Reining Walk-Jog

Reviewed 3/22/2018

Pattern #423

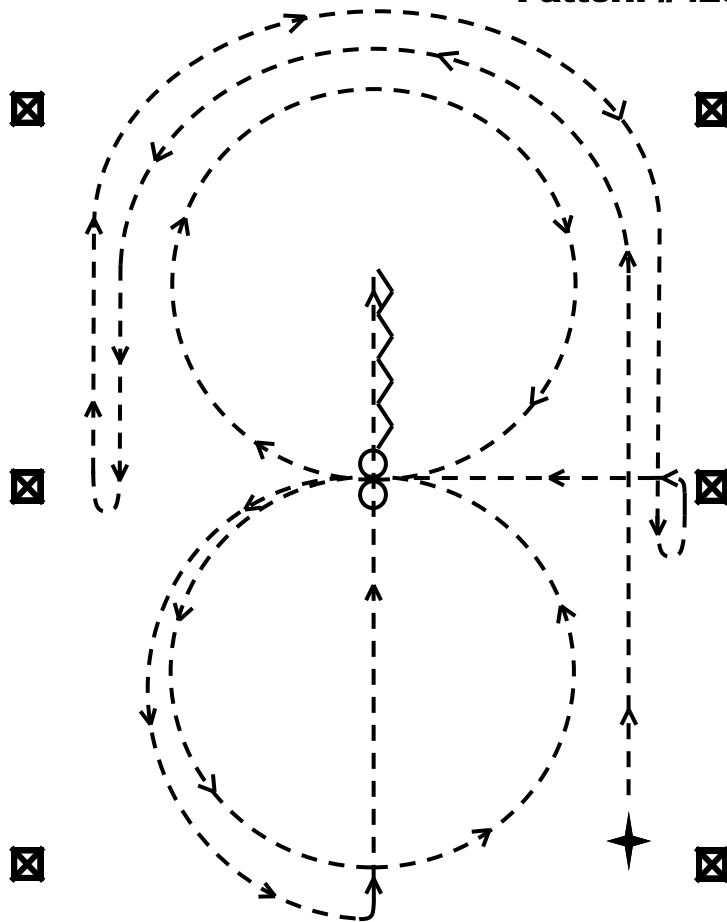

Begin at 

1. Jog up side of arena, around end, and straight down opposite side past center marker, stop, rollback, no hesitation .
2. Continue straight up side, around the end, and past center marker, stop, rollback, no hesitation , Continue to center of arena.
3. Complete 1 large circle to the left.
4. Complete 1 large circle to the right.
5. Stop in center, 1 spin to left
6. 1 spin to right..
7. Begin large circle to left. After 1/2 circle, turn and jog down center of arena, past center marker. Stop.
8. Back at least 5 steps.  
Hesitate to demonstrate completion of pattern.

# Reining Walk-Jog

Reviewed 3/22/2018

Pattern #424

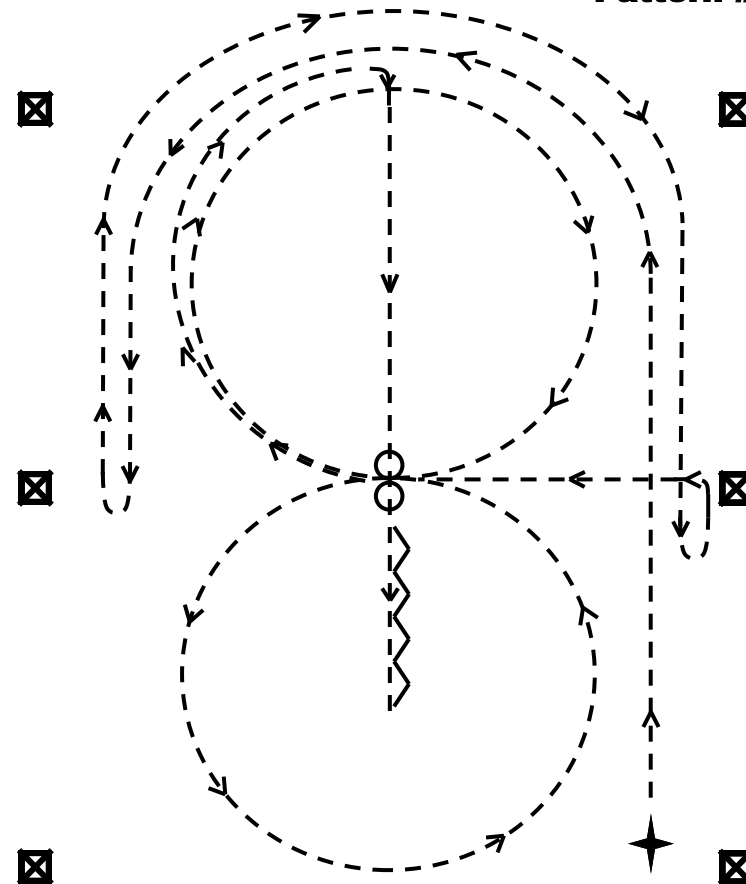

Begin at 

1. Jog up side of arena, around end, and straight down opposite side past center marker, stop, rollback, no hesitation .
2. Continue straight up side, around the end, and past center marker, stop, rollback, no hesitation , Continue to center of arena.
3. Complete 1 large circle to the right.
4. Complete 1 large circle to the left. Stop in center,
5. 1 spin to left
6. 1 spin to right.
7. Begin large circle to right. After 1/2 circle, turn and jog down center of arena, past center marker. Stop.
8. Back at least 5 steps.  
Hesitate to demonstrate completion of pattern.

# Reining Jr

Reviewed 3/22/2018

## Pattern #121

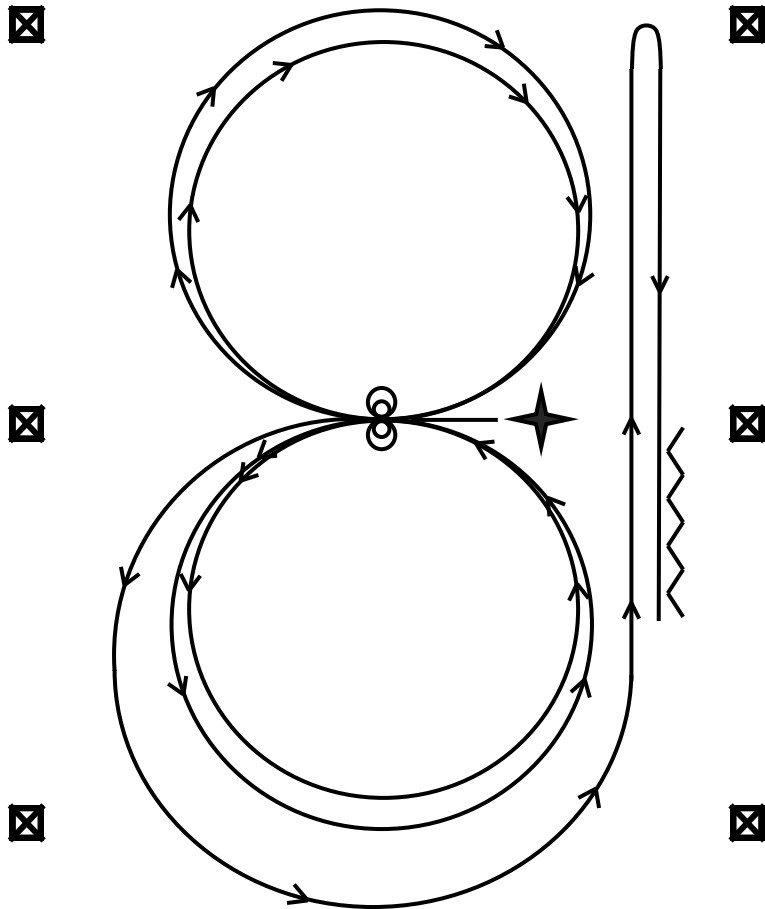

*May walk or jog to starting point*

Begin at 

1. Walk to center of arena.
2. Complete 2 large circles to the left, change leads
3. Complete 2 large circles to the right, Stop in center,
4. 2 spin to left,
5. 2 spin to right.
6. Begin large circle to left do not close circle Continue around end of arena and up side Stop, rollback, no hesitation
7. Continue past center marker Stop.
8. Back at least 5 steps.  
Hesitate to demonstrate completion of pattern.

# Reining Jr

Reviewed 3/22/2018

## Pattern #122

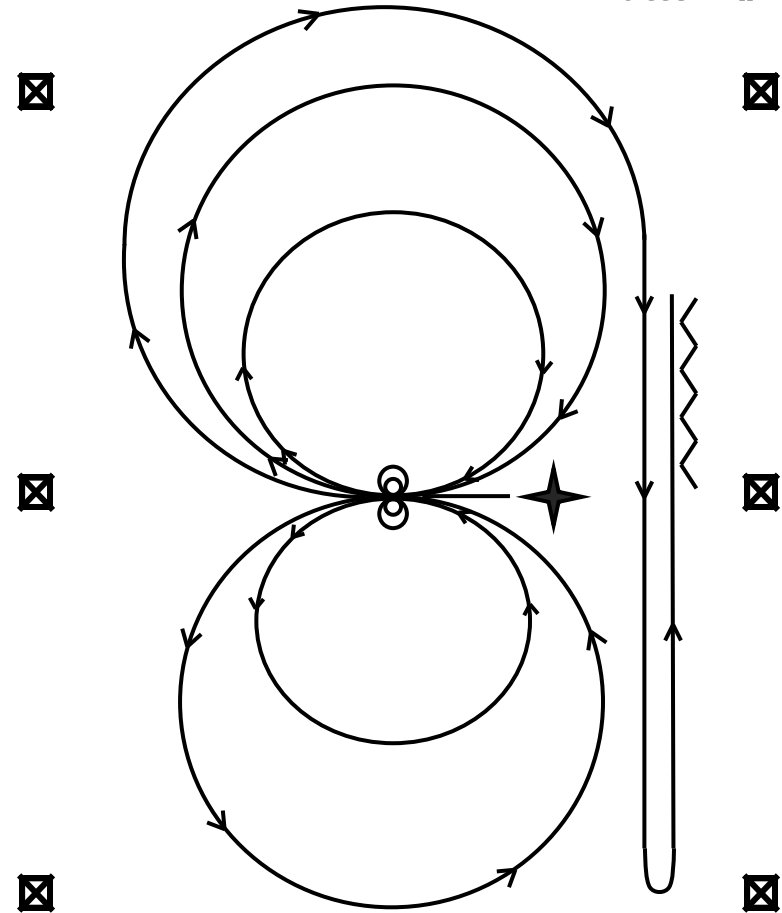

*May walk or jog to starting point*

Begin at 

1. Walk to center of arena.
2. Complete 2 circles to the right, 1 small slow, 1 large fast, change leads
3. Complete 2 circles to the left, 1 small slow, 1 large fast, Stop in center
4. 2 spin to right,
5. 2 spin to left.
6. Begin large circle to right, do not close circle Continue around end of arena and up side Stop, rollback, no hesitation
7. Continue past center marker Stop.
8. Back at least 5 steps.  
Hesitate to demonstrate completion of pattern.

# Reining Jr

Reviewed 3/22/2018

## Pattern #123

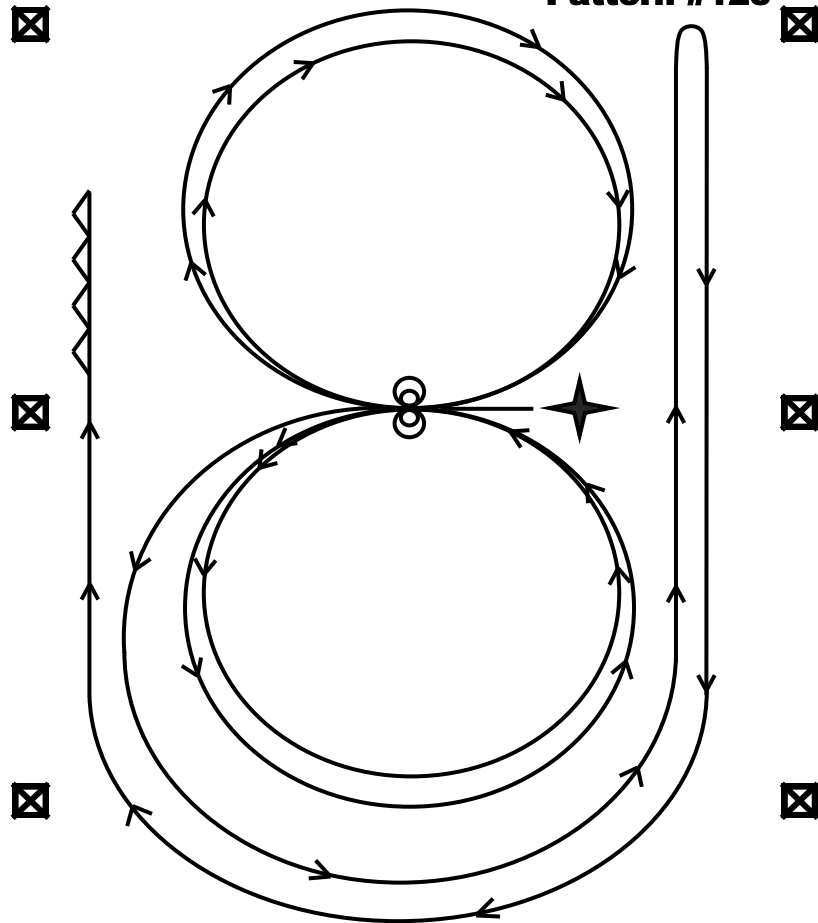

*May walk or jog to starting point*

Begin at 

1. Walk to center of arena.
2. Stop in center, 2 spins to left
3. 2 spins to right..
4. Complete 2 large circles to the left. Lead change at center
5. Complete 2 large circles to the right. Lead change at center
6. Begin large circle to left, do not close circle. Continue around end of arena and up side past center marker; stop, rollback, no hesitation
7. Continue around end of arena, and up side past center marker Stop.
8. Back at least 5 steps.

Hesitate to demonstrate completion of pattern.

# Reining Jr

Reviewed 3/22/2018

## Pattern #124

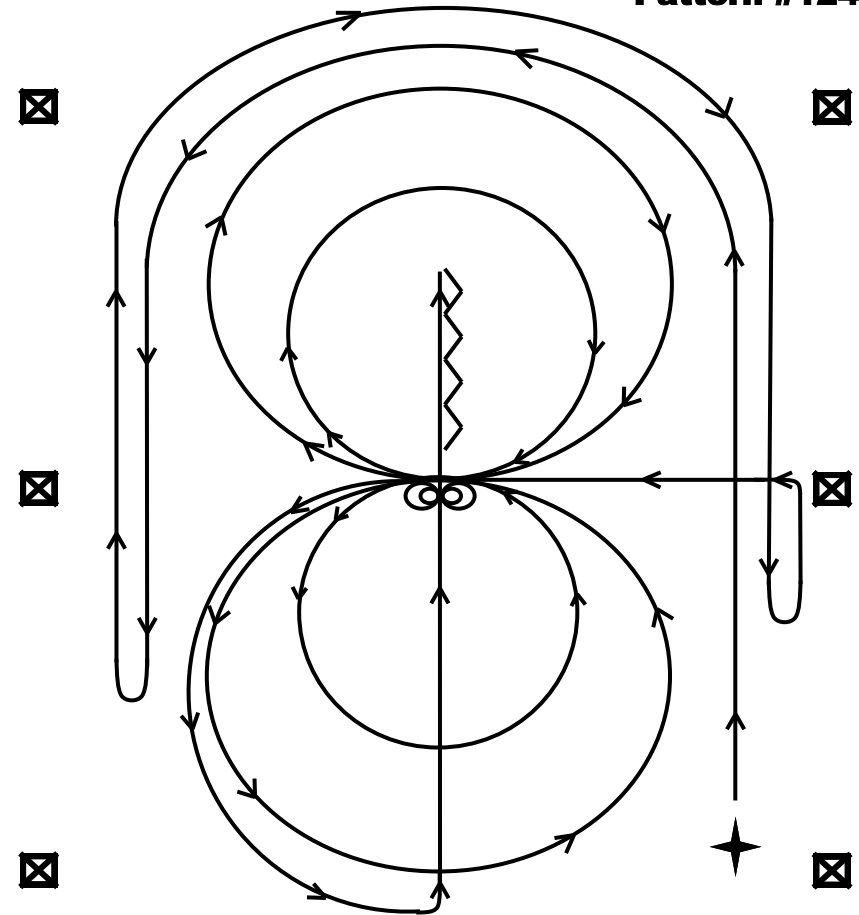

*May walk or jog to starting point*

Begin at 

1. Run up side of arena, around end, run straight down opposite side past center marker, stop, rollback, no hesitation .
2. Continue straight up side, around the end, past center marker, stop, rollback, no hesitation Continue to center of arena.
3. Complete 2 circles to the left, 1 large fast, 1 small slow. Lead change at center.
4. Complete 2 circles to the right. 1 large fast, 1 small slow. Lead change at center.
5. Begin large circle to left. After 1/2 circle, turn and run down center of arena, past center marker. Stop.
6. Back at least 5 steps.
7. 2 spins to left,
8. 2 spins to right.

Hesitate to demonstrate completion of pattern.

# Reining Int

Reviewed 3/22/2018

## Pattern #221

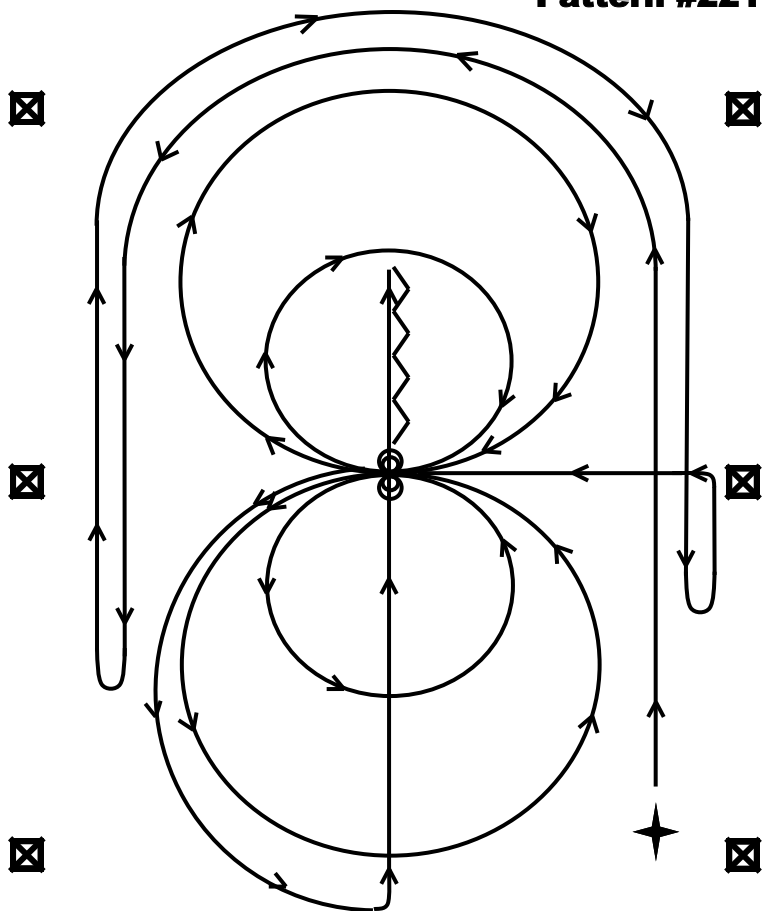

Begin at 

1. Run up side of arena, around end, run straight down opposite side past center marker, stop, rollback, no hesitation .
2. Continue straight up side, around the end, run straight down past center marker, stop, rollback., no hesitation. Continue to center of arena.
3. Complete 2 circles to the Left. 1 large and fast, 1 small and slow. Change Leads
4. Complete 2 circles to the right. 1large and fast, 1 small and slow. Stop in center,
5. 2 spins to left.
6. 2 spins to right.
7. Begin large circle to left. After 1/2 circle, turn and run down center of arena, past center marker. Stop.
8. Back at least 10 steps.

Hesitate to demonstrate completion of pattern.

# Reining Int

Reviewed 3/22/2018

## Pattern #222

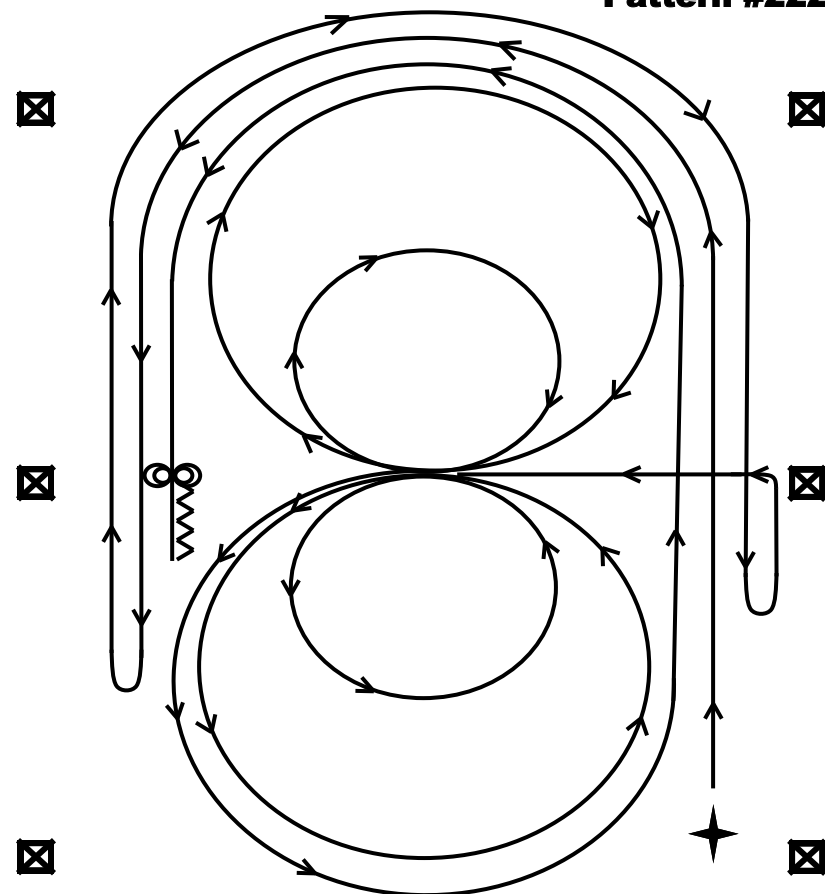

Begin at 

1. Run up side of arena, around end, straight down opposite side past center marker, stop, rollback, no hesitation .
2. Continue straight up side, around the end, straight down past center marker, stop, rollback., no hesitation. Continue to center of arena.
3. Complete 2 circles to the Left. 1 large and fast, 1 small and slow. Change leads at Center of arena.
4. Complete 2 circles to the right. 1 large and fast, 1 small and slow. Change leads at Center of arena.
5. Begin large circle to left, but do not close circle. Continue around end of arena and down opposite side past center marker. Stop.
6. Back at least 10 steps.
7. Complete 2 spins to the left
8. Complete 2 spins to the right.

Hesitate to demonstrate completion of pattern.

# Reining Int

Reviewed 3/22/2018

Pattern #223

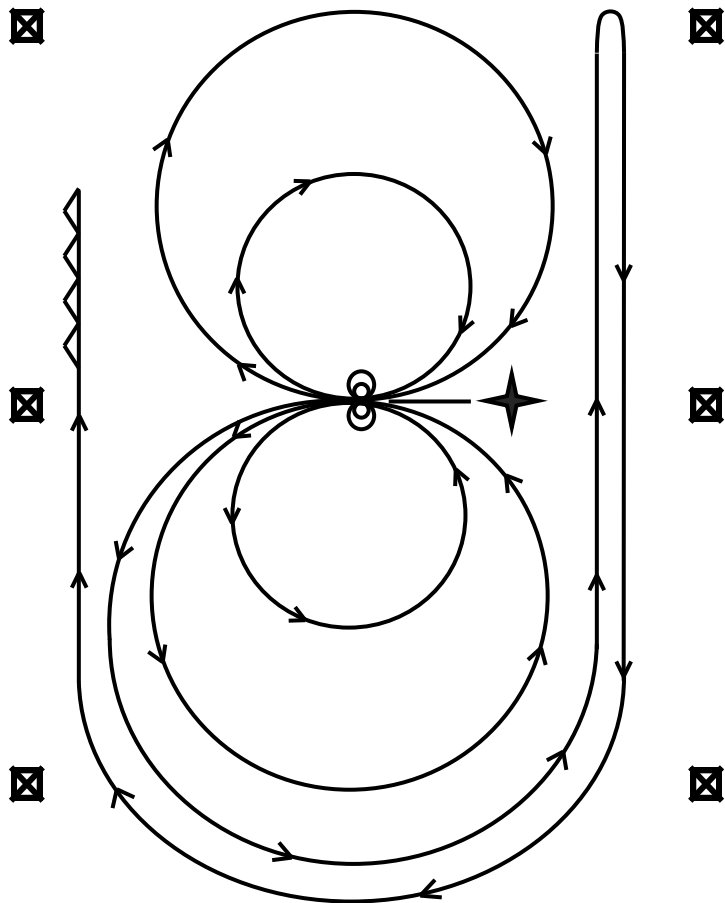

# Reining

Reviewed 3/22/2018

Pattern #

*May walk or jog to starting point*

1. Begin at  Walk to center of arena
2. Complete 2 spins to the left
3. Complete 2 spins to the right.
4. Complete 2 circles to the Left. 1 large and fast, 1 small and slow.  
Change leads at Center of arena.
5. Complete 2 circles to the right. 1 large and fast, 1 small and slow.  
Change leads at Center of arena.
6. Continue around end, run straight down opposite side, stop, rollback,  
no hesitation .
7. Continue straight up side, around the end, run straight down past  
center marker Stop.
8. Back at least 10 steps.  
Hesitate to demonstrate completion of pattern.

# Reining Sr

Reviewed 3/22/2018

## Pattern #321

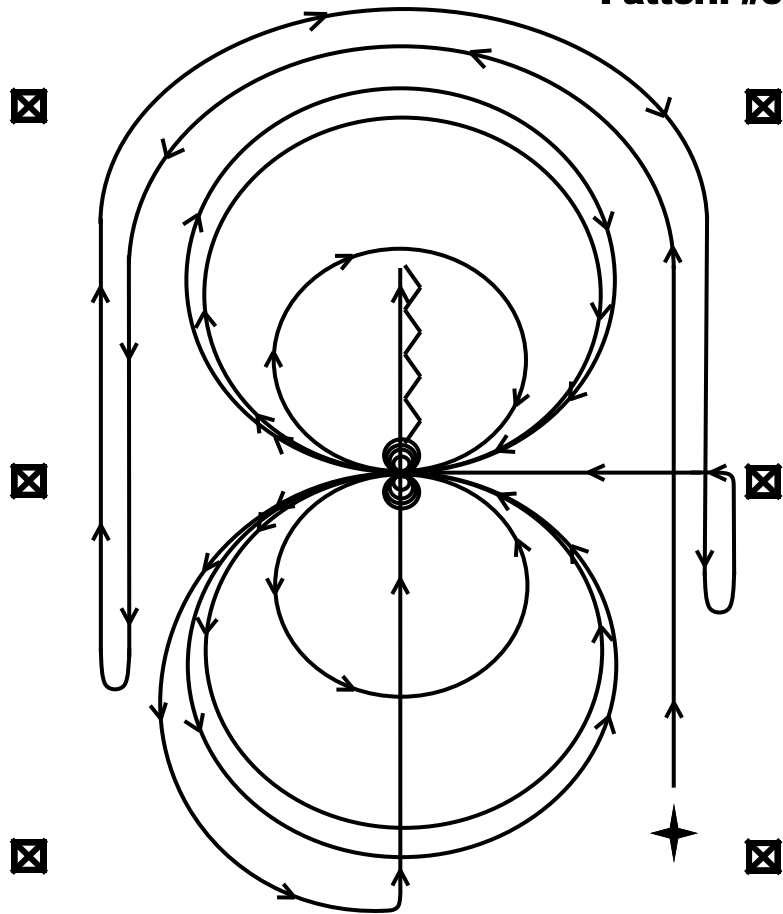

Begin at ★

1. Run up side of arena, around end, run straight down opposite side past center marker, stop, rollback, no hesitation .
2. Continue straight up side, around the end, run straight down past center marker, stop, rollback., no hesitation Continue to center of arena.
3. Complete 3 circles to the Left. 2 large and fast, 1 small and slow. Stop in center,
4. 4 spins to left,
5. 4 spins to right
6. Complete 3 circles to the right. 2 large and fast, 1 small and slow. Lead change in center
7. Begin large circle to left. After 1/2 circle, turn and run down center of arena, past center marker. Stop.
8. Back at least 10 steps.  
Hesitate to demonstrate completion of pattern.

# Reining Sr

Reviewed 3/22/2018

## Pattern #322

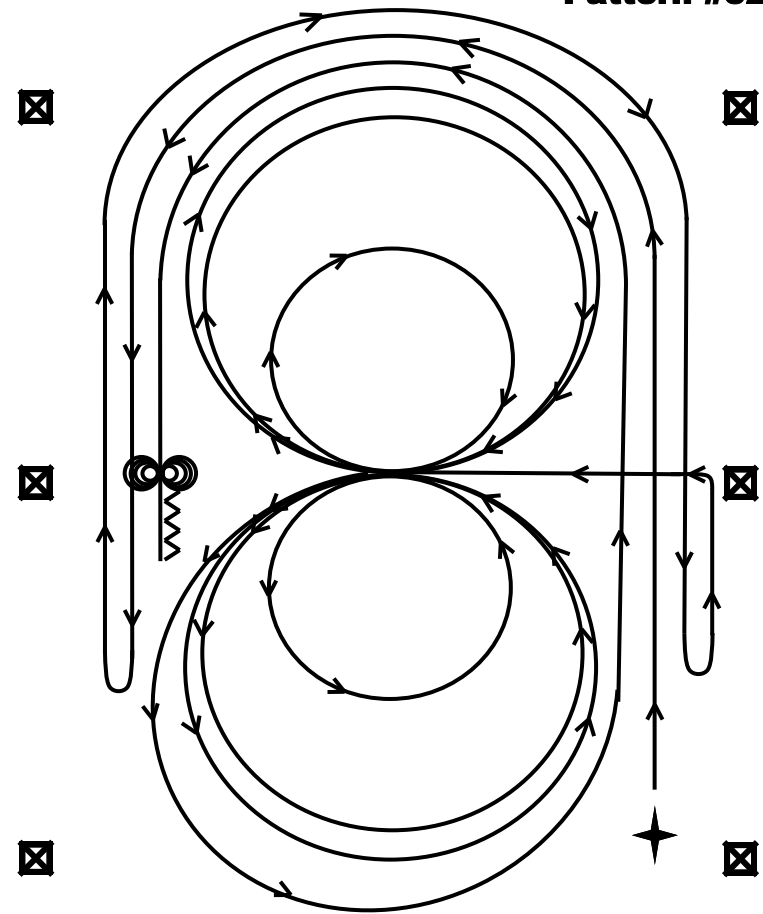

Begin at ★

1. Run up side of arena, around end, run straight down opposite side past center marker, stop, rollback, no hesitation .
2. Continue straight up side, around the end, run straight down past center marker, stop, rollback, no hesitation Continue up side, to center of arena.
3. Complete 3 circles to the Left. 2 large and fast, 1 small and slow. Change leads at Center of arena.
4. Complete 3 circles to the right. 2 large and fast, 1 small and slow. Change leads at Center of arena.
5. Begin large circle to left, but do not close circle. Continue around end of arena and down opposite side past center marker. Stop.
6. Back at least 10 steps.
7. Complete 4 spins to the left
8. Complete 4 spins to the right.  
Hesitate to demonstrate completion of pattern.

# Reining Sr

Reviewed 3/22/2018

Pattern #323

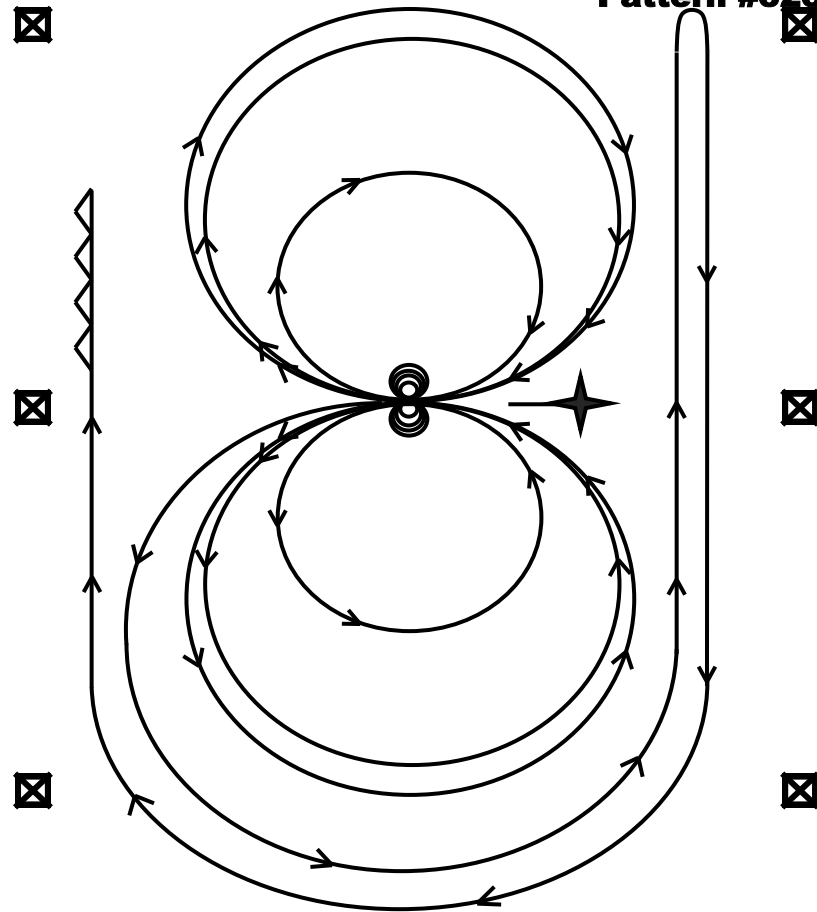

*May walk or jog to starting point*

Begin at  Walk to center of arena.

1. Complete 4 spins to the left
2. Complete 4 spins to the right.
3. Complete 3 circles to the Left. 1 small and slow. 2 large and fast, Change leads at Center of arena.
4. Complete 3 circles to the right. 1 small and slow. 2 large and fast, Change leads at Center of arena.
5. Continue around end, run straight down opposite side, stop, rollback, no hesitation .
6. Continue straight up side, around the end, run straight down past center marker. Stop.
7. Back at least 10 steps.  
Hesitate to demonstrate completion of pattern.

# Reining Sr

Reviewed 3/22/2018

Pattern #

# Ranch Riding Jr

Reviewed 3/22/2018

## Pattern #131

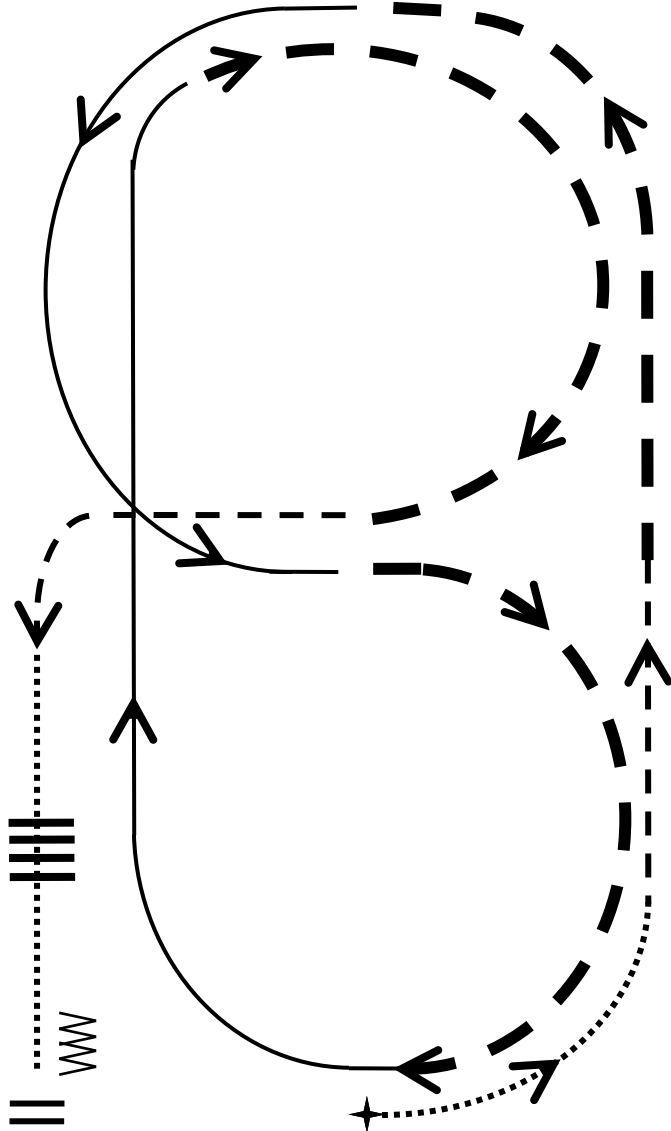

- Begin at ✦
1. Walk
  2. Trot
  3. Extend the trot.
  4. Left lead 1/2 circle, lope to center
  5. Extended Trot Right 1/2 circle
  6. Lope Right lead up side of arena
  7. Collect to Extended trot around end of arena and back to center
  8. Slow down to jog
  9. Walk over poles
  10. Stop and back.

Walk	.....	Ext Trot	— —	Stop		Lead Change	///
Trot	- - -	Ext Lope	— — —	Back		Side-Pass	==>
Lope	—						

# Ranch Riding Jr

Reviewed 3/22/2018

## Pattern #132

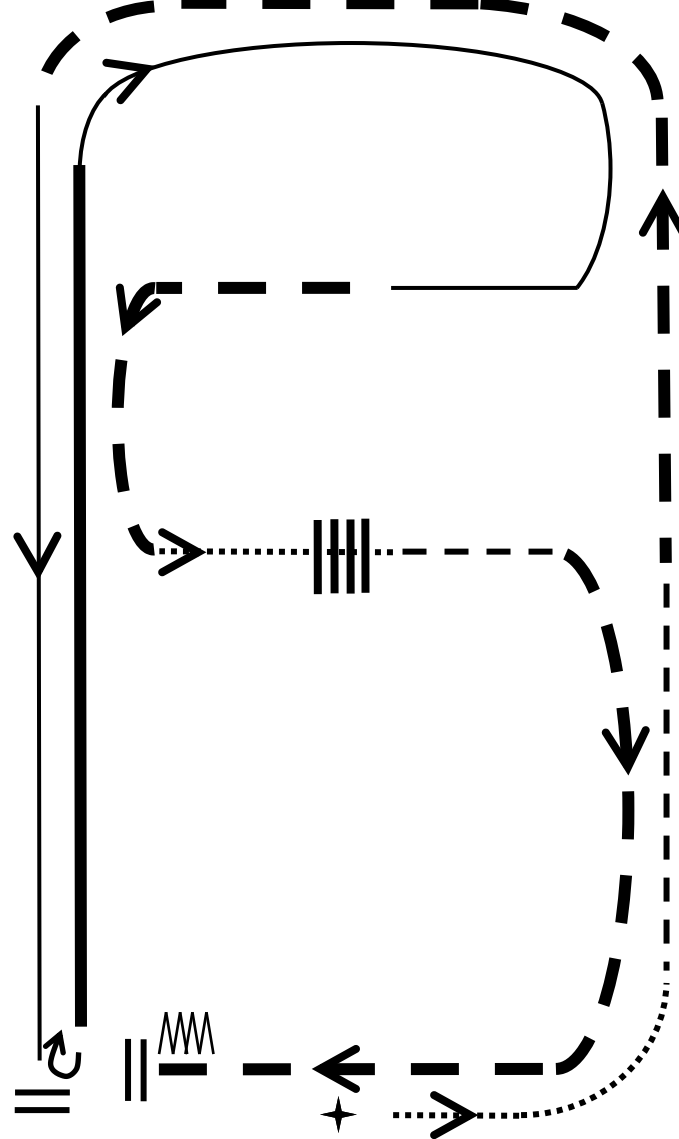

- Begin at ✦
1. Walk
  2. Trot
  3. Extend the trot.
  4. Left Lead Lope
  5. Stop, 1/2 turn right
  6. Extend the lope
  7. Collect to lope—right lead
  8. Break down to Extended trot
  9. Walk
  10. Walk over poles
  11. Trot
  12. Extend the Trot
  13. Stop and back.

Walk	.....	Ext Trot	— —	Stop		Lead Change	///
Trot	- - -	Ext Lope	— — —	Back		Side-Pass	==>
Lope	—						



# Ranch Riding Jr

Reviewed 3/22/2018

## Pattern #133

- Begin at ✦
1. Walk
  2. Trot
  3. Extend the trot to center of arena
  4. Stop, Side-pass Right.
  5. 90 degree turn each direction (either way first)
  6. Walk
  7. Extended Trot
  8. Lope Left lead
  9. Extend the lope
  10. Change leads, (simple or flying)
  11. Collect to Lope
  12. Break down to jog
  13. Stop and back.

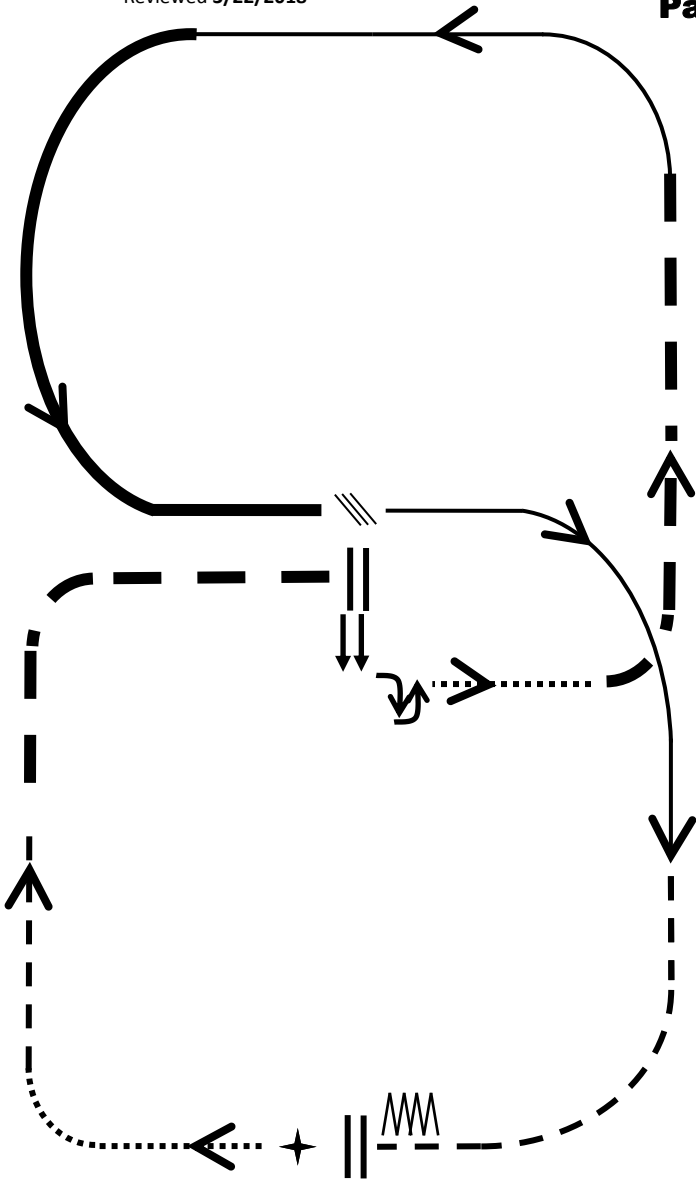

Walk	.....	Ext Trot	— — —	Stop	≡	Lead Change	≡
Trot	- - - -	Ext Lope	— — — —	Back	≡	Side-Pass	⇒
Lope	— — — —						

# Ranch Riding Jr

Reviewed 3/22/2018

## Pattern #134

- Begin at ✦
1. Walk
  2. Trot
  3. Lope left lead around end of arena and then diagonal across arena
  4. Break to Extended Trot
  5. Lope right lead around end of arena
  6. Extend Lope on side and around end of arena
  7. Extended trot around corner.
  8. Collect to Trot.
  9. Trot over poles
  10. Walk
  11. Stop and back.

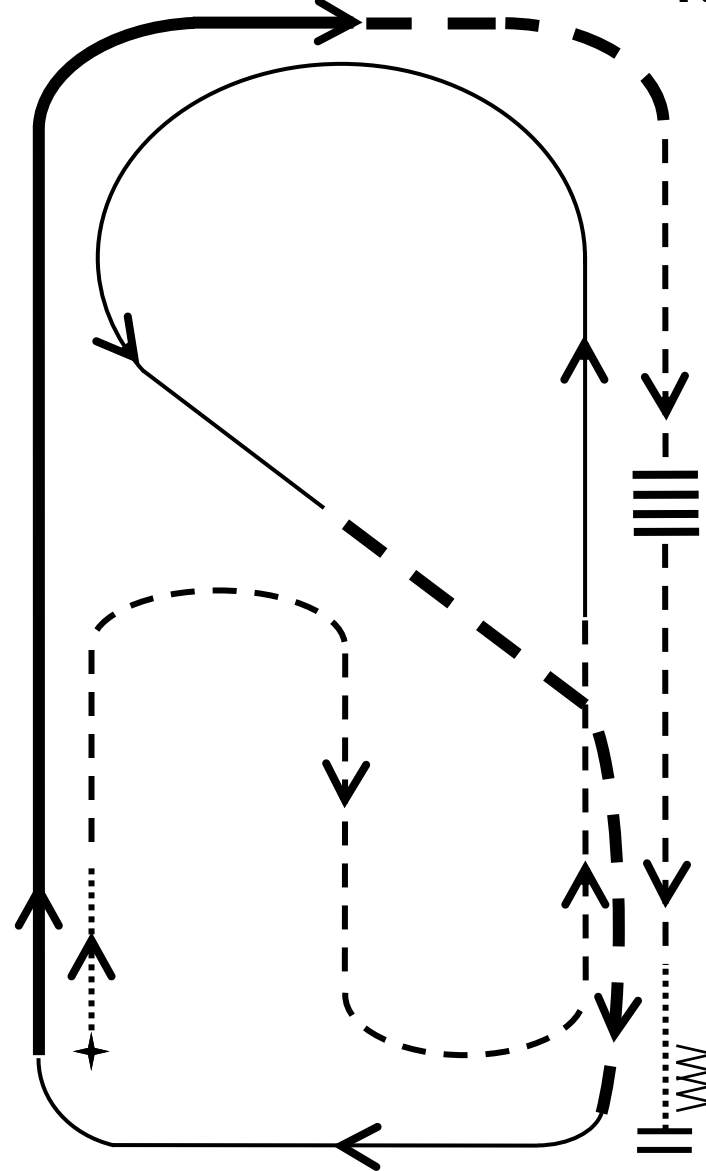

Walk	.....	Ext Trot	— — —	Stop	≡	Lead Change	≡
Trot	- - - -	Ext Lope	— — — —	Back	≡	Side-Pass	⇒
Lope	— — — —						



# Ranch Riding Int & Sr

Reviewed 3/22/2018

## Pattern #333

- Begin at ✦
1. Walk
  2. Trot
  3. Extend the trot to center of arena
  4. Stop, Side-pass Right.
  5. 360 degree turn each direction (either way first)
  6. Walk
  7. Extended Trot
  8. Lope Left lead
  9. Extend the lope
  10. Change leads, (simple or flying)
  11. Collect to Lope
  12. Break down to Trot
  13. Stop and back.

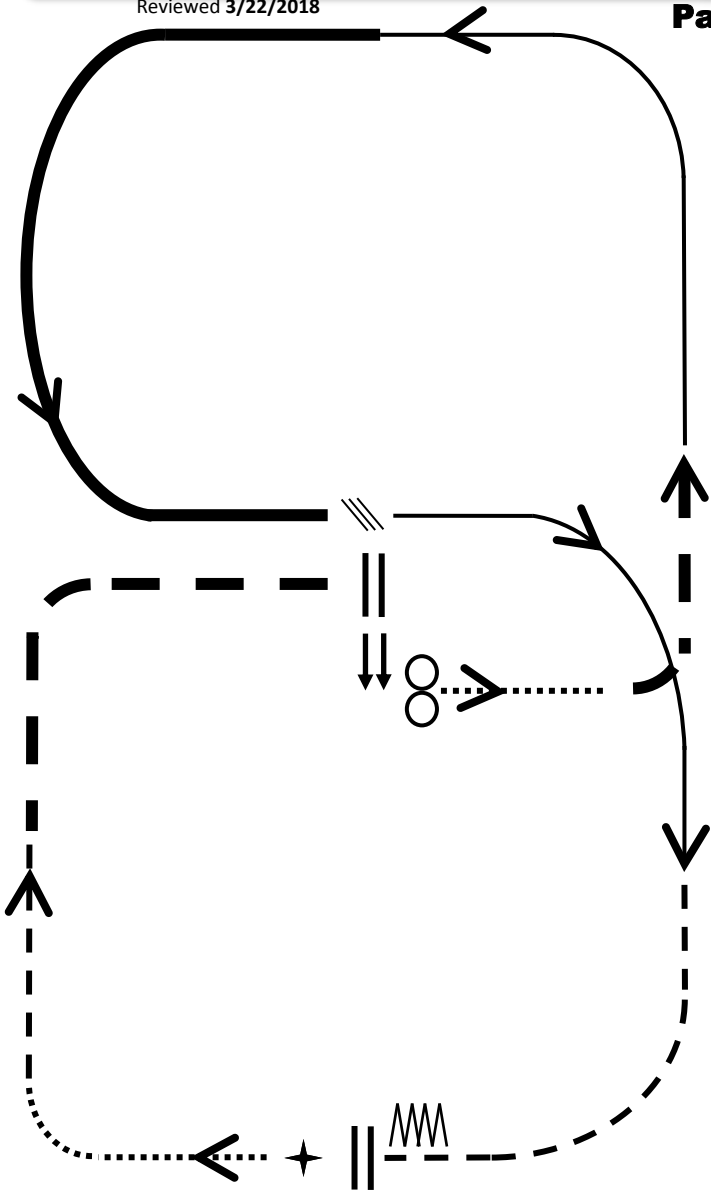

Walk	.....	Ext Trot	— —	Stop	≡	Lead Change	≡≡
Trot	- - -	Ext Lope	— — —	Back	≡≡≡	Side-Pass	⇒⇒
Lope	—						

# Ranch Riding Int & Sr

Reviewed 3/22/2018

## Pattern #334

- Begin at ✦
1. Walk
  2. Trot
  3. Lope left lead around end of arena and then diagonal across arena
  4. Change leads, (simple or flying)
  5. Lope right lead around end of arena
  6. Extend Lope on side and around end of arena
  7. Extended trot around corner.
  8. Collect to trot.
  9. Trot over poles
  10. Stop, 360 degree turn each direction (either way first)
  11. Walk
  12. Stop and back.

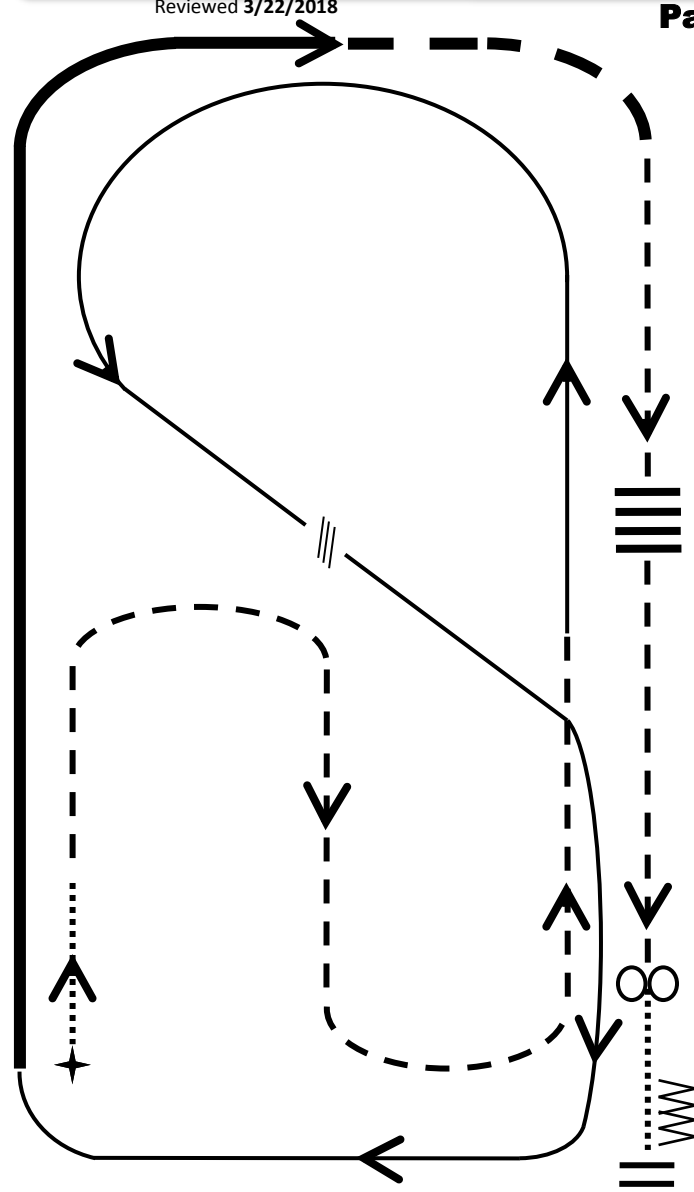

Walk	.....	Ext Trot	— —	Stop	≡	Lead Change	≡≡
Trot	- - -	Ext Lope	— — —	Back	≡≡≡	Side-Pass	⇒⇒
Lope	—						



# Trail Obstacles

Box Options:  
Step into, Step through, Turn around:

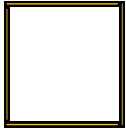

L - Options:  
Walk through, Back through, Step over from sides.

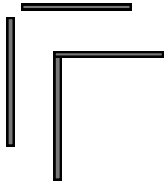

Backing obstacles must be spaced at least 28"

Modified L

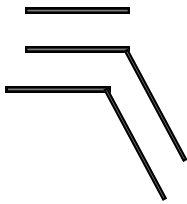

Box with L combo

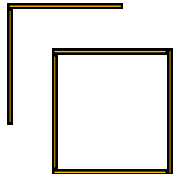

Box with L and elevated Diagonal

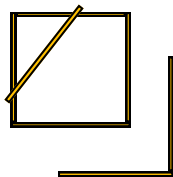

Bridge - Options :



Step onto from any direction. Stop in middle. Back off (advanced)

Bridge with L combo

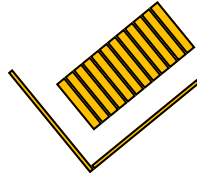

Bridge with open L combo

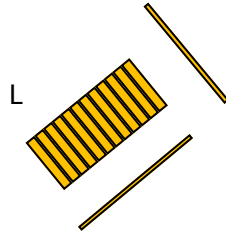

Walk-over 20-24" apart



Trot-over 36-39" apart



Elevated poles - must not be able to roll

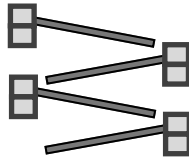

Walk-over 20-24" apart, elevated 12" max.

Trot-over 36-39" apart, elevated 8" max.

Side-pass between barrels.  
Option: pick up item and move to other barrel

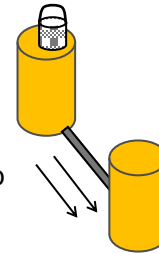

Barrel with bucket on top



Mailbox - open and close



May side-pass over pole to mailbox

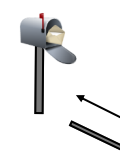

Barrels and cones combo. Walk or jog through.

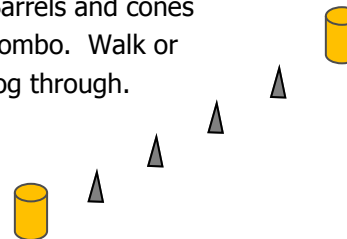

Barrels:  
Walk or jog through or around.

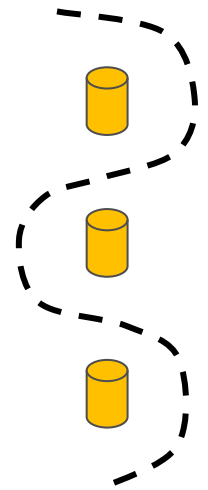

Cones:  
walk or jog through or around.



Gate:  
Rope or metal. Open and close.



# MINI Showmanship

Reviewed 5/30/2019

Pattern #901

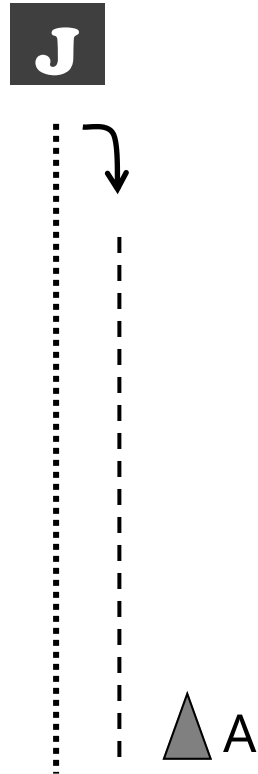
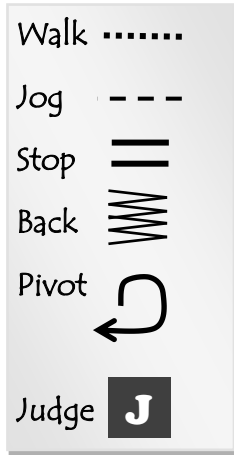

1. Set up at **A**
2. Walk to **Judge**, Set up for Inspection
3. Pivot, Trot to **A**
4. Stop
5. Walk to line-up or exit as instructed.

# MINI Showmanship

Reviewed 5/30/2019

Pattern #902

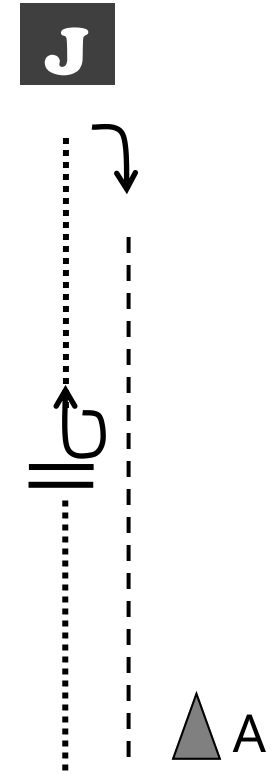
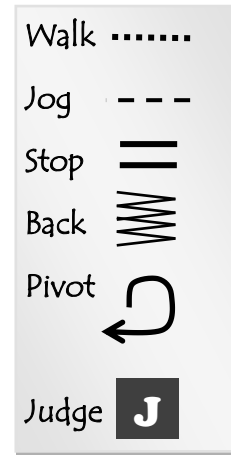

1. Set up at **A**
2. Walk toward **Judge**
3. At halfway, Stop
4. Pivot
5. Walk to **Judge**, Set up for Inspection
6. Pivot, Trot to **A**
7. Stop.
8. Walk to line-up or exit as instructed

# MINI Showmanship

Reviewed 5/30/2019

Pattern #903

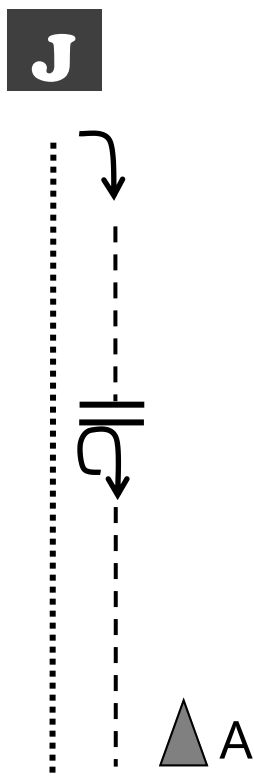

1. Set up at **A**
2. Walk to **Judge**, Set up for Inspection
3. Pivot 360°Trot toward **A**
4. At halfway, Stop
5. Pivot, Trot to **A**
6. Stop.
7. Walk to line-up or exit as instructed

Walk .....

Jog - - - -

Stop ||

Back ||||

Pivot ↻

Judge **J**

# MINI Showmanship

Reviewed 5/30/2019

Pattern #904

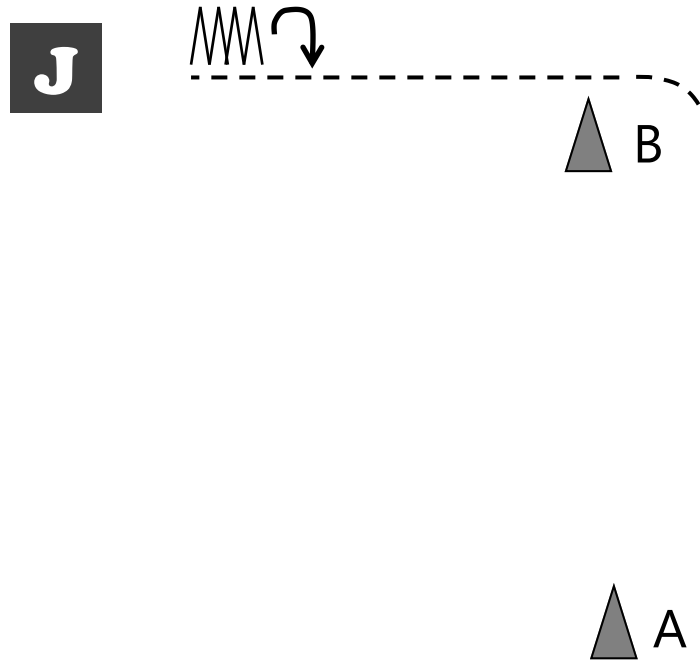

1. Set up at **A**,
2. Walk to **B**
3. Trot around B to Judge
4. Stop, Set up for Inspection
5. Back 5 steps
6. Pivot 270°
7. Walk to line-up or exit as instructed.

Walk .....

Jog - - - -

Stop ||

Back ||||

Pivot ↻

Judge **J**





# Mini Obstacle Driving

Reviewed 5/30/19

Pattern #910

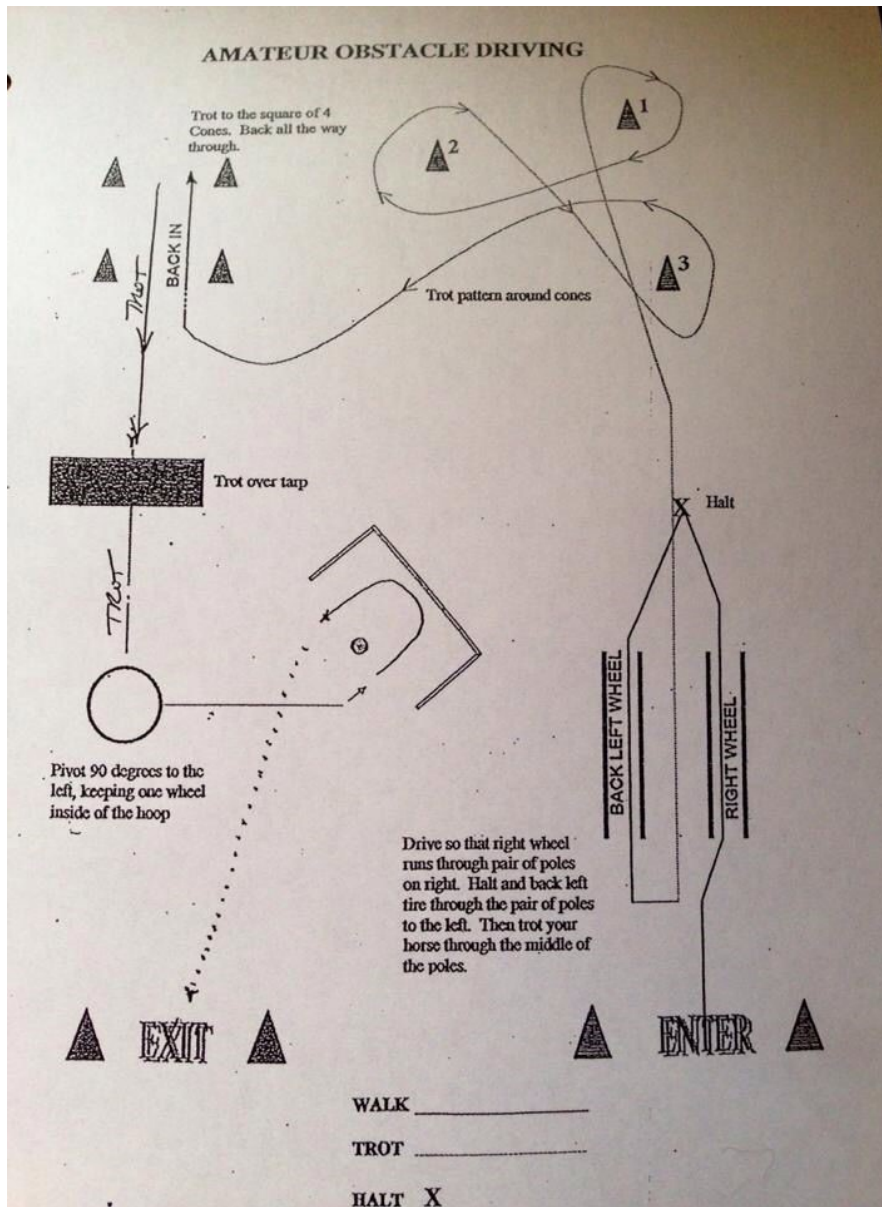

# Mini Obstacle Driving

Reviewed 5/30/19

Pattern #911

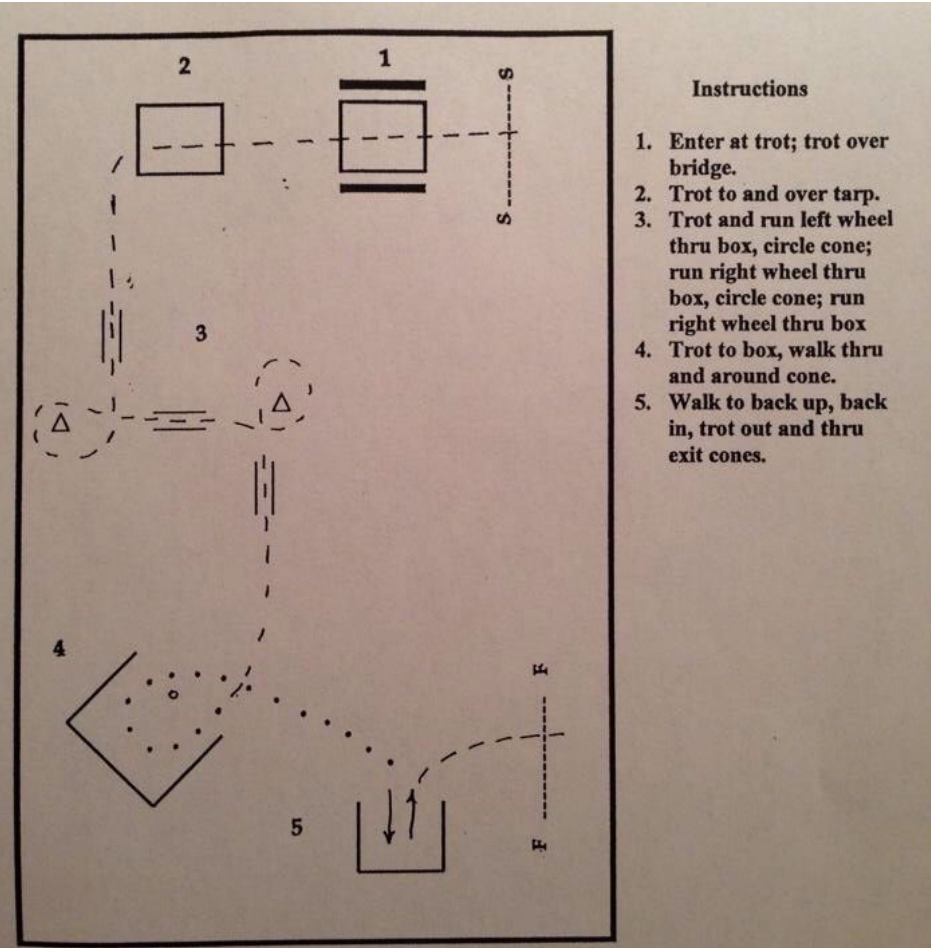

# MINI Trail Obstacles

Box Options:  
Step into, Step through, Turn around: 30" MINIMUM

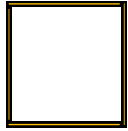

L - Options:  
Walk through, Back through, Step over form sides.

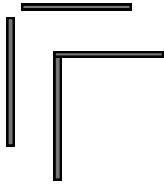

Backing obstacles minimum width 28"

Modified L

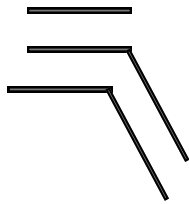

Box with L combo

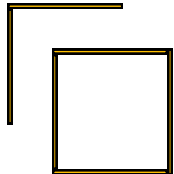

Box with L and elevated Diagonal

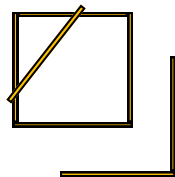

Bridge - Options :  
Step onto from any direction. Stop in middle. Back off (advanced)



Bridge with L combo

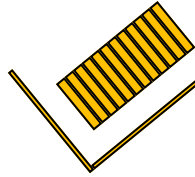

Bridge with open L combo

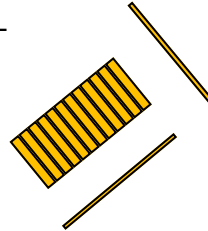

Walk-over width  
Mini 20-24"  
Pony 24-30"



Trot-over width  
Mini 30"  
Pony 36"

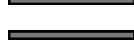

Elevated poles - must not be able to roll.  
Elevation Maximum  
Mini 6"  
Pony 10"

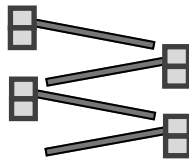

Side-pass between barrels.  
Option: pick up item and move to other barrel

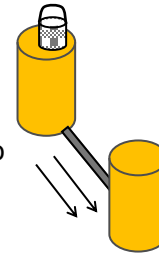

Barrel with bucket on top



Mailbox - open and close



May side-pass over pole to mailbox

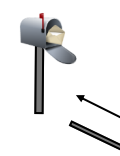

Barrels and cones combo. Walk or jog through.

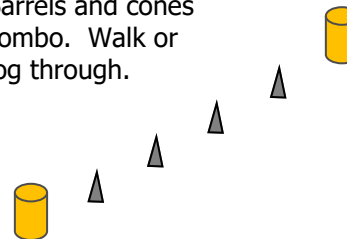

Barrels:  
Walk or jog through or around.

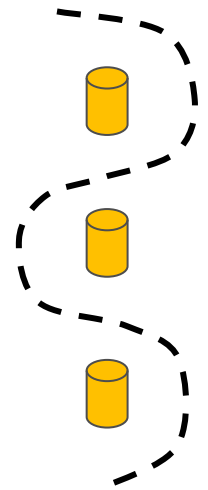

Cones:  
walk or jog through or around.



Gate:  
Rope or metal.  
Open and close.

